

RESTRICTED
FOR OFFICIAL USE ONLY

AN 08-10-209

★

*HANDBOOK OF MAINTENANCE
INSTRUCTIONS*

FOR

RADIO RECEIVERS

BC-348-E	•	BC-348-M	•	BC-348-O
BC-348-P	•	BC-348-S	•	BC-224-E
BC-224-G	•	BC-224-H	•	BC-224-L

NOTICE: This document contains information affecting the national defense of the United States within the meaning of the Espionage Act, 50 U.S.C., 31 and 32, as amended. Its transmission or the revelation of its contents in any manner to any unauthorized person is prohibited by law. (AR 380-5) (ARTS 75½ & 76, U. S. N. REGS-1920).

The information contained in restricted documents and the essential characteristics of restricted material will not be communicated to the public or to the press, but may be given to any person known to be in the service of the United States and to persons of undoubted loyalty and discretion who are cooperating in Government work.

NOTICE: For Official Use Only—Not to be communicated to anyone outside His Majesty's Service.

Not to be published. The information given in this document is not to be communicated, either directly or indirectly, to the press or to any person not holding an official position in His Majesty's Service.

Published under joint authority of the United States War and Navy
Departments and the Air Council of the United Kingdom.

SECURITY NOTICE

FOR U. S. PERSONNEL: This document contains information affecting the national defense of the United States within the meaning of the Espionage Act, 50 U.S.C., 31 and 32, as amended. Its transmission or the revelation of its contents in any manner to an unauthorized person is prohibited by law. (AR 380-5) (ARTS 75½ & 76, U.S.N. REGS-1920.)

The information contained in restricted documents and the essential characteristics of restricted materiel will not be communicated to the public or to the press, but may be given to any

person known to be in the service of the United States and to persons of undoubted loyalty and discretion who are cooperating in Government work.

FOR BRITISH PERSONNEL: For Official Use Only—Not to be communicated to anyone outside His Majesty's Service. Not to be published. The information given in this document is not to be communicated, either directly or indirectly, to the press or to any person not holding an official position in His Majesty's Service.

LIST OF REVISED PAGES ISSUED

NOTE: A heavy black vertical line, to the left of the text on revised pages, indicates the extent of the revision. This line is omitted where more than 50 percent of the page is revised.

Page No.	Latest Revised Date
Title Page ...	1 March 1944
A	1 March 1944
II	1 March 1944
VII	1 March 1944
15	1 March 1944

ADDITIONAL COPIES OF THIS PUBLICATION MAY BE OBTAINED AS FOLLOWS:

AAF ACTIVITIES—Submit requisitions to the Commanding General, Fairfield Air Service Command, Patterson Field, Fairfield, Ohio, Attention: Publications Distribution Branch, in accordance with AAF Regulation No. 5-9. Also, for details of Technical Order distribution, see T. O. No. 00-25-3.
NAVY ACTIVITIES—Submit requests to the Chief, Bureau of Aeronautics, Navy Department, Washington, D. C.
BRITISH ACTIVITIES—Submit requirements on Form 294A, in duplicate, to the Air Publications and Forms Store, New College, Leadhall Lane, Harrogate, Yorkshire, England.

TABLE OF CONTENTS

<i>Section</i>	<i>Page</i>
DESTRUCTION NOTICE	v
UNSATISFACTORY REPORT	vi
SAFETY NOTICE	vii
REPLACEMENT NOTICE	vii
I. GENERAL DESCRIPTION	
1. General	1
2. Component Units	1
<i>a.</i> Cabinet	2
<i>b.</i> Chassis	2
<i>c.</i> Panel	2
<i>d.</i> R-F and Oscillator Units	3
<i>e.</i> I-F Transformers, Beat Frequency Oscillator and Crystal Filter	3
<i>f.</i> Mounting	3
<i>g.</i> Plug PL-P103 and Plug PL-Q103	3
<i>b.</i> Illumination	3
<i>i.</i> Dynamotor DM-28-(*) or D-M24-(*)	3
3. Power Requirements	4
4. Tube Description	4
II. INSTALLATION AND ADJUSTMENT	
1. Installation	5
<i>a.</i> Mounting	5
<i>b.</i> Power Connections	5
<i>c.</i> Transmitter Connections	5
<i>d.</i> Output Connections	5
<i>e.</i> Bonding and Shielding	6
<i>f.</i> Mounting of Receiver	6
<i>g.</i> Safety Wire	6
<i>b.</i> Ground	6
<i>i.</i> Antenna	6
2. Preparation for Use	6
III. OPERATION	
1. General Procedure	7
<i>a.</i> Power Switch	7
<i>b.</i> Operating Test	7
<i>c.</i> Operating Routine	7
IV. MECHANICAL AND ELECTRICAL CHARACTERISTICS	
1. Circuits	9
2. Frequency Range and Frequency Bands	9
3. Input Coupling	9

TABLE OF CONTENTS (Continued)

<i>Section</i>	<i>Page</i>
4. Input Protection	9
5. Radio-Frequency Amplifier	11
6. First Detector	11
7. Heterodyne Oscillator	11
8. Intermediate-Frequency Amplifier	11
9. C-W Oscillator	11
10. Crystal Band-Pass Filter	12
11. Second Detector and Automatic Volume Control	12
12. Output	12
<i>a.</i> Description	12
<i>b.</i> Constant Internal Receiver Noise	12
<i>c.</i> Output Impedance	13
13. Dynamotor	13
14. Dial and Mask Assembly	13
V. MAINTENANCE	
1. Inspection	15
<i>a.</i> Daily	15
<i>b.</i> 25 Hours	15
<i>c.</i> 100 Hours	15
<i>d.</i> Major Overhaul	15
2. Replacement of Dial Lamps and Fuses	15
<i>a.</i> Dial Lamps	15
<i>b.</i> Fuses	15
3. Care and Servicing of Dynamotor	15
<i>a.</i> Procedure for Removal	15
<i>b.</i> Lubrication	15
<i>c.</i> Servicing Ball Bearings and Commutators	15
<i>d.</i> Smoothing the Commutator	16
<i>e.</i> Reassembly of the Dynamotor	17
<i>f.</i> Nominal Ratings	17
4. Removal of Front Panel	17
5. Dial and Mask Assembly	18
<i>a.</i> General	18
<i>b.</i> Switch Drive Shaft	18
<i>c.</i> Stop-Arm Assembly	18
<i>d.</i> Index Plate	18
<i>e.</i> Dial Hub	18
<i>f.</i> Shafts	18
<i>g.</i> Gear Ratio	18
<i>b.</i> Dial Calibration	19

TABLE OF CONTENTS (Continued)

<i>Section</i>	<i>Page</i>
6. Removal and Replacement of Dial Mechanism	19
<i>a.</i> General	19
<i>b.</i> Procedure	19
<i>c.</i> Readjustment	19
<i>d.</i> Mask Setting	19
<i>e.</i> Removal of Backlash	19
<i>f.</i> Final Adjustment	19
7. Removal of Antenna, R-F, Detector and Oscillator Units	19
8. Trouble Location and Remedy	21
<i>a.</i> General	21
<i>b.</i> Equipment Required	21
<i>c.</i> Weak or No Signals on All Bands, Modulated Reception	21
<i>d.</i> Weak or No Signals on Any One Band, Modulated Reception	30
<i>e.</i> Weak or No Signals on All Bands, C-W Reception (Modulated Reception Normal) ..	30
<i>f.</i> Measurements with Test Set I-56-A	30
<i>g.</i> Failure of Dial Lights	32
VI. SUPPLEMENTARY DATA	33
VII. TABLE OF REPLACEABLE PARTS	39
VIII. DRAWINGS	66

LIST OF TABLES

<i>Table</i>	<i>Page</i>
I. Components, Dimensions and Weights	1
II. Alignment Data	25
III. Current and Voltage Measurements with "C.W. OSC." OFF	30
IV. Current and Voltage Measurements with "C.W. OSC." ON	31
V. Resistance to Ground (Ohms) with "C.W. OSC." OFF	31
VI. Resistance to Ground (Ohms) with "C.W. OSC." ON	32
VII. Tube Voltage and Current Chart	33
VIII. Characteristics of Tubes, Lamps, Voltage Regulator and Fuse	34
IX. Description of Transformers (Ref. Nos. 71-100)	34
X. Parts Described but Not Stocked	35
XI. RMA Color Codes	38

LIST OF ILLUSTRATIONS

<i>Figure</i>	<i>Page</i>
1. Radio Receiver BC-348-(★) or BC-224-(★)	VIII
2. Bottom and Back View of Cabinet	VIII
3. Radio Receiver BC-348-(★) or BC-224-(★), Front View of Chassis with Tube Shelf Cover Removed	2
4. Mounting with Plug PL-Q103 Attached	3
5. Mounting and Plugs PL-P103 and PL-Q103	4
6. Plug Connections	5
7. Radio Receiver BC-348-(★) or BC-224-(★), Top View of Chassis	9
8. Radio Receiver BC-348-(★) or BC-224-(★), Bottom View of Chassis	10
9. C-W Oscillator Switching	12
10. Details of Crystal Filter Circuit	12
11. Load Compensator and Bleeder Circuit Details	13
12. Details of Output Transformer Connections	13
13. Dynamotor DM-28-(★) or DM-24-(★), View Showing Filter Open	16
14. Dynamotor DM-28-(★) or DM-24-(★), Disassembled	17
15. Trouble Location and Correction Chart	20
16. Radio Receiver BC-348-(★), Dynamotor and Tube Socket Voltages	22
17. I-F Transformers, C-W Oscillator and Crystal Filter Assemblies	23
18. Radio Receiver BC-348-(★) or BC-224-(★), Rear View of Chassis	24
19. Antenna Unit	26
20. R-F Unit	27
21. Detector Unit	28
22. Oscillator Unit	29
23. Radio Receiver BC-348-(★) or BC-224-(★), Resistor Boards, View A	66
24. Radio Receiver BC-348-(★) or BC-224-(★), Resistor Boards, View B	66
25. Radio Receiver BC-348-(★) or BC-224-(★), Resistor Boards Wiring Diagram	67
26. Wiring Diagram, Dynamotor Filter	68
27. Wiring Diagram, Crystal Filter	69
28. Wiring Diagram, Beat Frequency Oscillator	70
29. Wiring Diagram, Oscillator Unit	71
30. Wiring Diagram, I-F Transformer	72
31. Radio Receiver BC-348-(★), Wiring Diagram, Tube Shelf	73
32. Radio Receiver BC-224-(★), Wiring Diagram, Tube Shelf	74
33. Wiring Diagram, Antenna Unit	75
34. Wiring Diagram, R-F Unit	76
35. Wiring Diagram, Detector Unit	77
36. Radio Receiver BC-348-(★), or BC-224-(★), Outline Dimensional Drawing	78
37. Radio Receiver BC-348-(★), Pictorial Wiring Diagram	79-80
38. Radio Receiver BC-224-(★), Pictorial Wiring Diagram	81-82
39. Radio Receiver BC-348-O or BC-348-S, Schematic Circuit Diagram	83-84
40. Radio Receiver BC-348-E, BC-348-M, or BC-348-P, Schematic Circuit Diagram	85-86
41. Radio Receiver BC-224-(★), Schematic Circuit Diagram	87-88

DESTRUCTION OF ABANDONED MATERIEL IN THE COMBAT ZONE

In case it should become necessary to prevent the capture of this equipment and when ordered to do so, **DESTROY IT SO THAT NO PART OF IT CAN BE SALVAGED, RECOGNIZED, OR USED BY THE ENEMY. BURN ALL PAPERS AND BOOKS.**

Means:-

1. Explosives, when provided.
2. Hammers, axes, sledges, machetes, or whatever heavy object is readily available.
3. Burning by means of incendiaries such as gasoline, oil, paper, or wood.
4. Grenades and shots from available arms.
5. Burying all debris or disposing of it in streams or other bodies of water, where possible and when time permits.

Procedure:-

1. Obliterate all identifying marks. Destroy nameplates and circuit labels.
2. Demolish all panels, castings, switch- and instrument-boards.
3. Destroy all controls, switches, relays, connections, and meters.
4. Rip out all wiring and cut interconnections of electrical equipment. Smash gas, oil, and water-cooling systems in gas-engine generators, etc.
5. Smash every electrical or mechanical part, whether rotating, moving, or fixed.
6. Break up all operating instruments such as keys, phones, microphones, etc.
7. Destroy all classes of carrying cases, straps, containers, etc.
8. Bury or scatter all debris.

DESTROY EVERYTHING!

UNSATISFACTORY REPORT

FOR U. S. ARMY AIR FORCE PERSONNEL:

In the event of malfunctioning, unsatisfactory design, or unsatisfactory installation of any of the component units of this equipment, or if the material contained in this book is considered inadequate or erroneous, an Unsatisfactory Report, AAF Form No. 54, or a report in similar form, shall be submitted in accordance with the provisions of Army Air Force Regulation No. 15-54, listing:

1. Station and organization.
2. Nameplate data (type number or complete nomenclature if nameplate is not attached to the equipment).
3. Date and nature of failure.
4. Airplane model and serial number.
5. Remedy used or proposed to prevent recurrence.
6. Handbook errors or inadequacies, if applicable.

FOR U. S. NAVY PERSONNEL:

Report of failure of any part of this equipment during its guaranteed life shall be made on Form N. Aer. 4112, "Report of Unsatisfactory or Defective Material," or a report in similar form, and forwarded in accordance with the latest instructions of the Bureau of Aeronautics. In addition to other distribution required, one copy shall be furnished to the inspector of Naval Material (location to be specified) and the Bureau of Ships. Such reports of failure shall include:

1. Reporting activity.
2. Nameplate data.
3. Date placed in service.
4. Part which failed.
5. Nature and cause of failure.
6. Replacement needed (yes—no).
7. Remedy used or proposed to prevent recurrence.

FOR BRITISH PERSONNEL:

Form 1022 procedure shall be used when reporting failure of radio equipment.

RESTRICTED
AN 08-10-209

SAFETY NOTICE

**OPERATING PERSONNEL MUST NOT
MAKE ANY ADJUSTMENTS INSIDE OF
THIS EQUIPMENT UNTIL THE POWER
SUPPLY HAS BEEN TURNED OFF.**

RESTRICTED
AN 08-10-209



Figure 1 — Radio Receiver BC-348-(*) or BC-224-(*)*

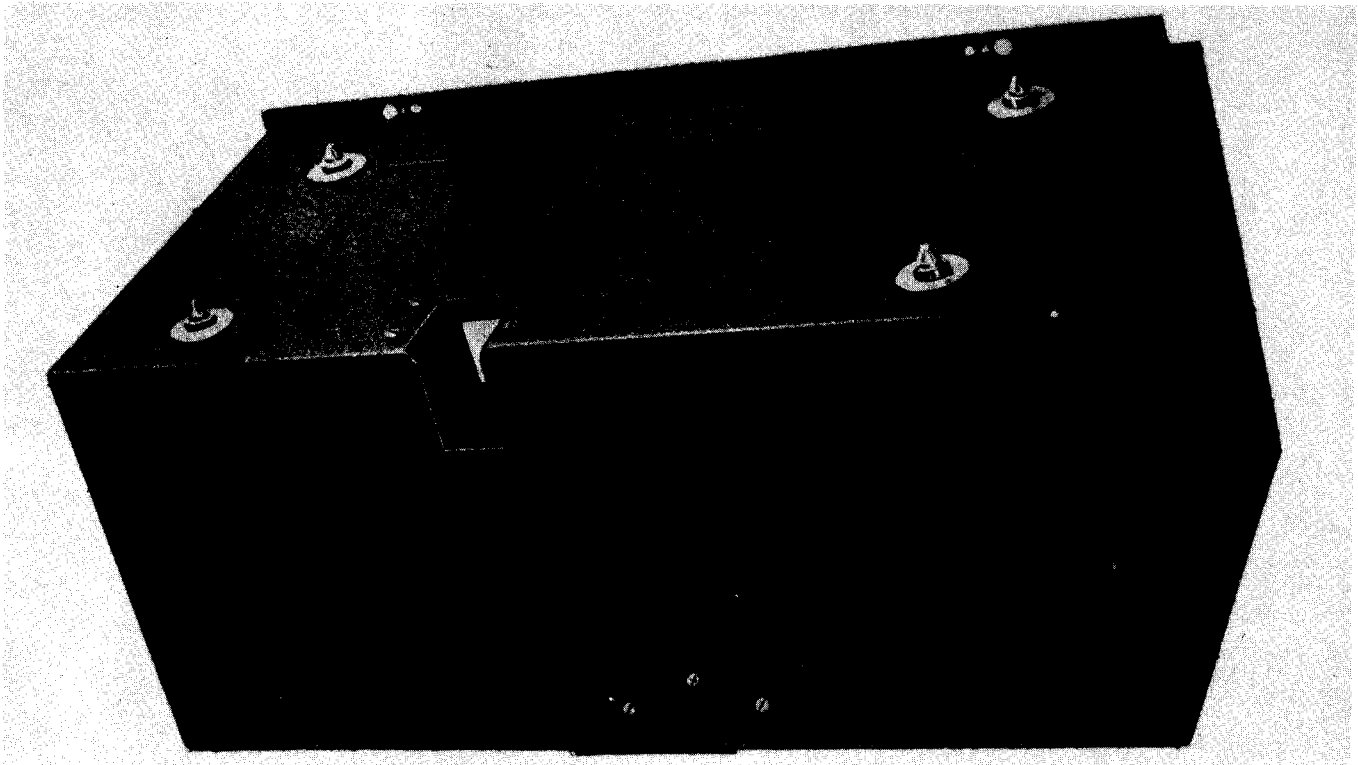

* See Special Notice, page 1.

Figure 2 — Bottom and Back View of Cabinet

HANDBOOK OF
MAINTENANCE INSTRUCTIONS
for
RADIO RECEIVERS

BC-348-E · BC-348-M · BC-348-O · BC-348-P · BC-348-S
BC-224-E · BC-224-G · BC-224-H · BC-224-L

SPECIAL NOTICE

The radio receivers covered in this handbook are essentially alike, therefore reference will be made to these equipments throughout the book as follows, except in certain cases: "Radio Receiver BC-348-() or BC-224-(*)." Reference to the dynamotors is made in the same manner (Dynamotor DM-28-(*) or DM-24-(*). Although illustrations show only Radio Receiver BC-348-O and its components, this equipment is representative of the others in the group dealt with in this book.*

**SECTION I
GENERAL DESCRIPTION**

1. GENERAL.

Each Radio Receiver BC-348-(*) or BC-224-(*)* is a locally controlled, eight-tube, six-band superheterodyne receiver intended for use in U. S. Army aircraft, and covers the frequency ranges of 200 to 500 kilocycles and 1.5 to 18.0 megacycles. All receivers in the 348 series are completely interchangeable within the series as are the receivers of the 224 series within that series. These receivers are not intended for remote control, and no features or units have been provided for remote operation. The receivers are capable of voice, tone, or c-w reception with manual or automatic volume control. When equipped with tubes, dial lights, and fuses and with the antenna, ground, and primary power source connections properly made, these receivers become complete and operative equipments by addition of headsets, inasmuch as all coils and the high-voltage power supply units are contained within the receivers. The total power consumed by these receivers is 56 watts from either a 28-volt or 14-volt d-c source.

Electrically, the filament circuit and high-voltage supply units differ in order to permit Radio Receivers BC-224-E, BC-224-G, BC-224-H, and BC-224-L to operate from a 14-volt power source, and Radio Receivers BC-348-E, BC-348-M, BC-348-O, BC-348-P, and BC-348-S

to operate from a 28-volt power source. A dowel pin fastened to the chassis of the latter receivers prevents accidental installation of the 14-volt dynamotor in the 28-volt receivers.

2. COMPONENT UNITS.

Following is a list of the major replaceable parts of the above receivers:

**TABLE I
COMPONENTS, DIMENSIONS AND WEIGHTS**

Quan.	Component	Dimensions (Inches)	Weights (Lbs.)
1	Fuse FU-35* or Fuse FU-23**	1 $\frac{1}{4}$ x 1 $\frac{1}{4}$ diam.	0.008
2	Lamp LM-27 each	1 $\frac{1}{8}$ x 3 $\frac{3}{8}$ diam.	0.005
1	Mounting (not including Plugs PL-P103 or PL-Q103)	1 $\frac{7}{16}$ x 8 $\frac{8}{16}$ x 18 $\frac{1}{16}$	4.1
1	Plug PL-P103 (straight)	1 $\frac{5}{8}$ x 2 $\frac{5}{32}$ x 2 $\frac{31}{32}$	0.34
1	Plug PL-Q103 (angle)	1 $\frac{5}{8}$ x 2 $\frac{5}{32}$ x 2 $\frac{3}{32}$	0.41

* Fuse FU-35 for 28-volt receiver.

** Fuse FU-23 for 14-volt receiver.

* See special notice above.

Section I
Paragraph 2

RESTRICTED
AN 08-10-209

Quan.	Component	Dimensions (Inches)	Weights (Lbs.)
1	Radio receiver including dynamotor and the following complement of tubes and equipped with all accessory components except headphones.	10 $\frac{7}{16}$ x 9 $\frac{9}{16}$ x 18	40.194
1	Tube VT-48 (JAN-41)		
1	Tube VT-65 (JAN-6C5)		
1	Tube VT-70 (JAN-6F7)		
3	Tube VT-86 each (JAN-6K7)		
1	Tube VT-91 (JAN-6J7)		
1	Tube VT-93 (JAN-6B8)		
1	Voltage regulator RCA991		

a. CABINET.—The receiver cabinet is of spot-welded aluminum construction with a black, wrinkle finish and is embossed on the top and back to add rigidity and strength. The panel (front) end allows the removal of the receiver chassis which runs on the stainless steel strips mounted in the end corners of the cabinet. Two tapped inserts are placed in the rear to receive the thumb screw rods which secure the chassis in the cabinet. A cut-

out in the rear bottom permits the entrance of Plug PL-P103 or PL-Q103. An aluminum casting is mounted over this cutout and acts as a seal between the cabinet and the chassis. The bottom of the cabinet is reinforced by a stainless steel plate to which are attached the four mounting studs for securing the cabinet to the mounting. Two snap slides are mounted on the downward projection of the front of the stainless steel plate. (See fig. 2.)

b. CHASSIS.—The chassis consists of an aluminum casting mounted between two end-plates of sheet aluminum which serve as runners and guides when placing the chassis in the cabinet. The end-plates are provided with cutouts to facilitate servicing. (See fig. 3.)

c. PANEL.—The front panel is attached to the chassis and to the end-plates by screws. Two handles are mounted on the panel and two thumb screw rods which secure the chassis in the cabinet pass through the lower part of these handles. A cutout covered by a plate is provided to give access to the wiring under the r-f tube shelf for servicing and maintenance. The following panel items are mounted on the front of the panel: antenna and ground binding posts (marked A and G in lower right hand corner), ANT. ALIGN. control, DIAL LIGHTS rheostat control, TUNING control, BAND SWITCH control, dial window housing which covers the dial

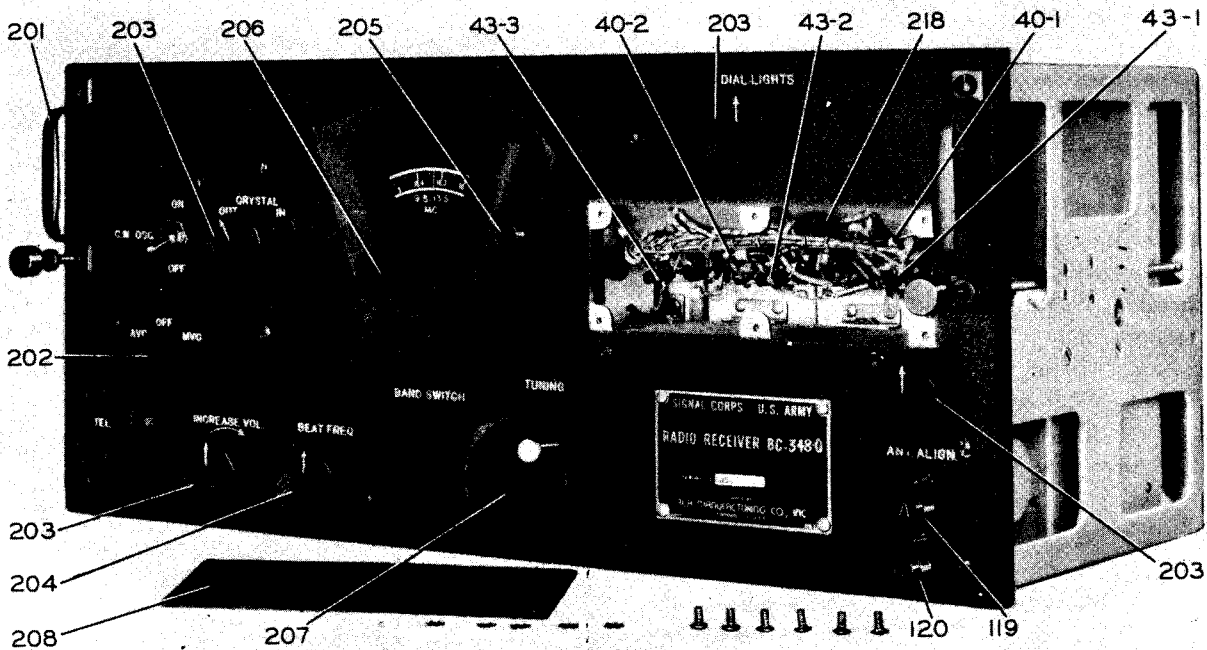

Figure 3 — Radio Receiver BC-348-(*) or BC-224-(*) , Front View of Chassis with Tube Shelf Cover Removed

RESTRICTED

lights, BEAT FREQ. control, CRYSTAL filter control, INCREASE VOL. control, AVC - OFF - MVC control, C.W. OSC. control, and two telephone jacks (marked TEL.). (See fig. 1.)

d. R-F AND OSCILLATOR UNITS.—The antenna, r-f, first detector, and oscillator sub-assemblies are mounted on the right rear portion of the chassis. Each sub-assembly consists of the r-f coils, trimmers, and band switch wafers with the necessary fixed capacitors and resistors. Passing through all of these sub-assemblies is the band switch drive shaft which is pulled out from the right end of the receiver chassis before a sub-assembly is removed.

e. I-F TRANSFORMERS, BEAT FREQUENCY OSCILLATOR AND CRYSTAL FILTER. — These units are mounted on the left, front portion of the chassis. The variable capacitor of the beat-frequency oscillator is controlled through a flexible shaft from the front panel.

f. MOUNTING. — Mounting FT-154-E, FT-154-L, FT-154-P, FT-154-T, or FT-154-W is constructed of stainless steel except for the aluminum bases which carry the mounting holes and to which are attached the bases of four shock absorbers. To the top of the shock absorbers is fastened the stainless steel support which provides

for the attachment of the receiver cabinet by means of studs and snapslides. Grooves are provided in the stainless steel support to facilitate the engagement of the studs of the cabinet with the mounting. (See fig. 4.)

g. PLUG PL-P103 AND PLUG PL-Q103.—The plug, attached to the mounting by screws, is provided with eight terminals which are accessible upon removal of the rear cover of the plug housing. If provided with a straight outlet, Plug PL-P103 is used. With a right angle outlet, which may be mounted in any of three positions, right, left or back, Plug PL-Q103 is used. The position and use of these outlets with the plug are clearly shown on the outline dimensional drawing in figure 35.

b. ILLUMINATION.—The receiver tuning dial is illuminated by means of two dial lights (Lamp LM-27) controlled by the DIAL LIGHTS rheostat. This rheostat has an off position when the illumination is not desired. The dial lights are located beneath a readily removable housing which permits the easy replacement of a dial lamp during flight.

i. DYNAMOTOR DM-28-(★) or DM-24-(★).—The dynamotor and associated r-f filter circuits are assembled in one unit. The r-f filters are of the unbalanced type for use with a primary power supply in which the negative

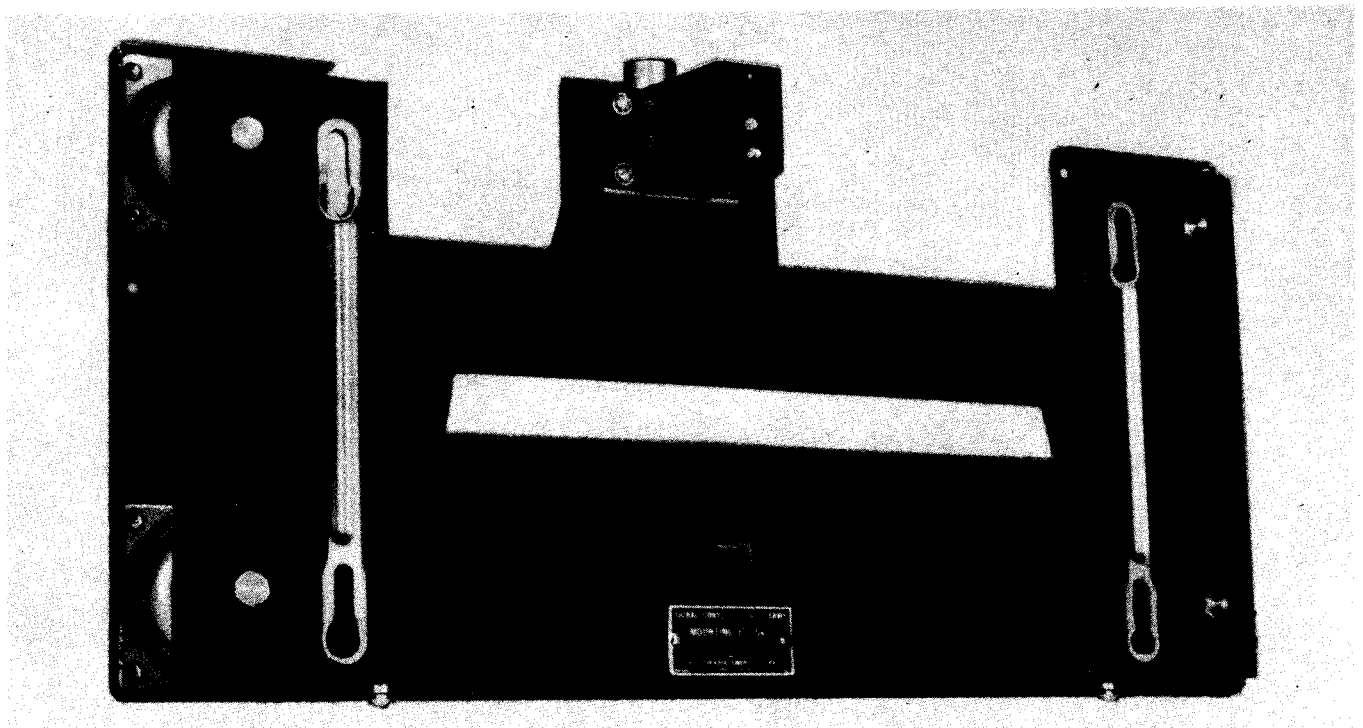

Figure 4 — Mounting with Plug PL-Q103 Attached

side is grounded. This dynamotor supplies all of the high-voltage direct current required for the operation of the receiver and, in addition, a maximum of 20 milliamperes for use in operating accessory equipment.

3. POWER REQUIREMENTS.

Total power consumed by the receivers is 56 watts from either a 28-volt or 14-volt d-c source. The plate voltage required for normal operation is 250 volts direct current.

4. TUBE DESCRIPTION.

<i>Tube</i>	<i>Nomenclature</i>	<i>Function</i>
VT-86	JAN-6K7	1st r-f amplifier
VT-86	JAN-6K7	2nd r-f amplifier
VT-91	JAN-6J7	1st detector
VT-65	JAN-6C5	Oscillator
VT-86	JAN-6K7	1st i-f amplifier
VT-70	JAN-6F7	C-W oscillator and 2nd i-f
VT-93	JAN-6B8	3rd i-f and 2nd detector
VT-48	JAN-41	Audio output amplifier

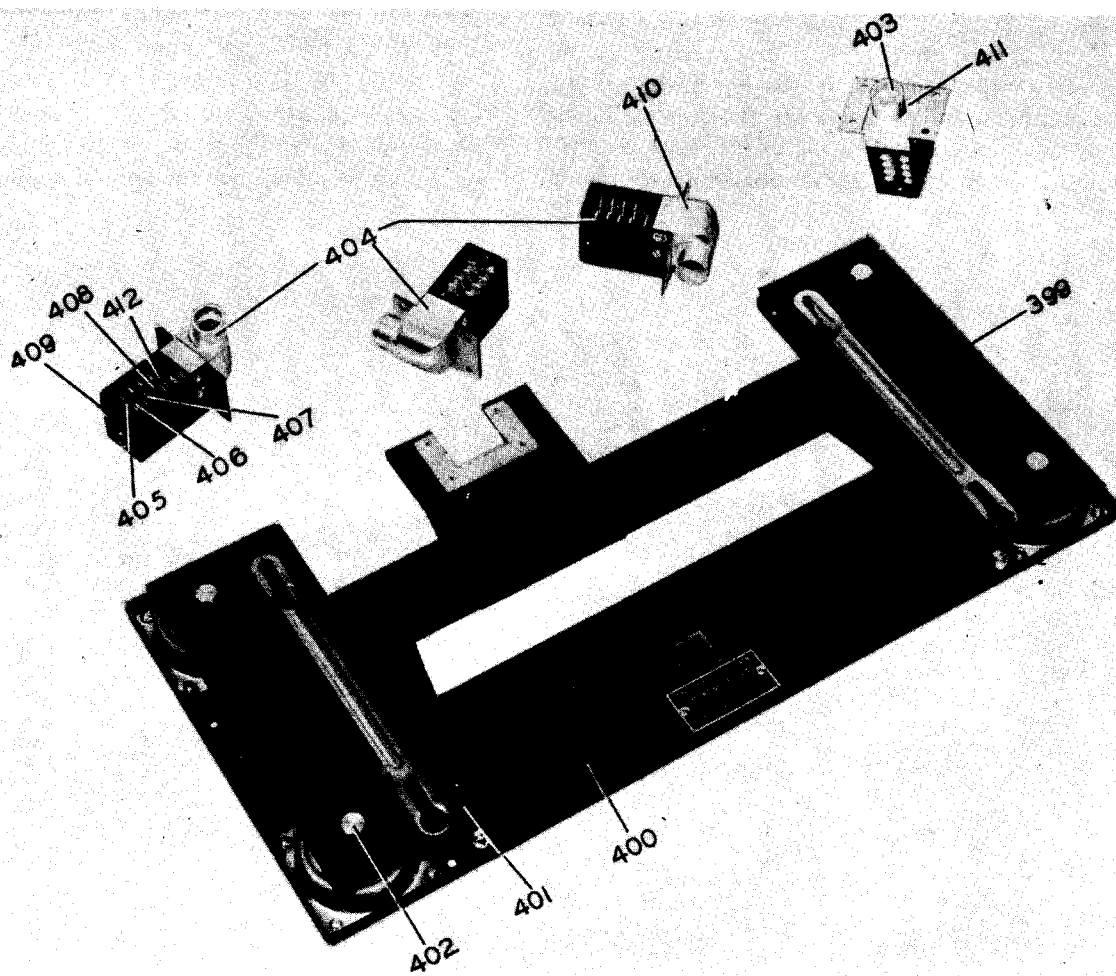

Figure 5 — Mounting and Plugs PL-P103 and PL-Q103

SECTION II INSTALLATION AND ADJUSTMENT

1. INSTALLATION:

a. MOUNTING.—Mount the receiver on a flat surface with sufficient clearance allowed on all sides to permit free action of the shock absorber mounting. Permanently attach the mounting to the rigid members of the plane.

b. POWER CONNECTIONS.—The leads to the primary power source are connected as shown in figure 6. The parallel connected leads from plug terminals 3 and 4 may be replaced by a single conductor of cross section equivalent to the two separate leads. Similarly, the parallel connected leads from plug terminals 7 and 8 may be replaced by a single conductor of equivalent cross sectional area.

c. TRANSMITTER CONNECTIONS. — Provisions have been made for the protection of this receiver when

the associated transmitter is being used. Wire the leads from plug terminals 2 and 6 to contacts on the transmitter relay. If the transmitter is removed from the installations, or if the receiver is being installed without an associated transmitter, the wires from plug terminals 2 and 6 must be connected together in order to have the receiver operate.

d. OUTPUT CONNECTIONS.—The output of this receiver has been brought to plug terminals 1 and 5 and to the two front-panel jacks. Wire the leads from these terminals to the interphone system or wherever desired. If the output is desired only at the receiver, take it directly from the phone jacks and make no connections to plug terminals 1 and 5. Provision has been made to change the output from high to low impedance by removing the lead wire from terminal #4 of the output transformer and connecting it to terminal #2.

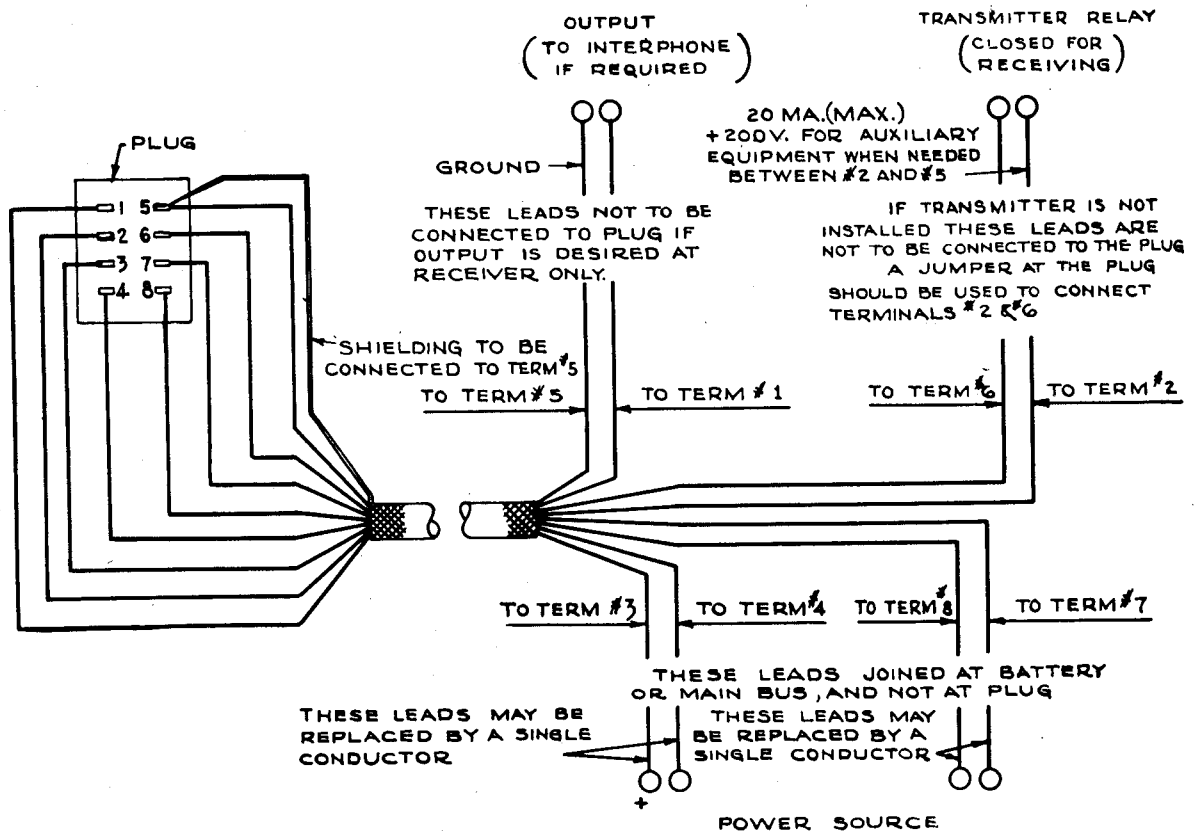

Figure 6 — Plug Connections

e. **BONDING AND SHIELDING.**—At the time of installation of this equipment, make sure the engine ignition system, generator, and other possible causes of disturbance are properly shielded and that bonding of metal parts is carefully carried out according to Army Air Forces Specification No. 32310-B.

f. **MOUNTING OF RECEIVER.**—When proper wiring connections have been made, place the receiver on its mounting with the studs on the bottom of the cabinet entering the slots of the mounting. See that the cabinet is well down on the mounting and that all four studs are fully seated, then push the cabinet towards the rear and secure in place by the snapslides on the lower front corners of the cabinet. (See fig. 2.)

g. **SAFETY WIRE.** — Pass safety wire through the holes of the snapslide assemblies, but be sure that the wires are not twisted too tightly.

b. **GROUND.**—Connect the ground binding post "G" by a short, direct, low-resistance lead to some grounded metal portion of the plane and solder at that point if practicable. Make sure that the lead has enough slack to prevent vibration being transmitted to the receiver.

i. **ANTENNA.**—The antenna circuit aligning capacitor is operative on bands 2, 3, 4, 5, and 6. No external adjustment is required for band 1. The alignment capacitor is such that the antenna circuit can be properly aligned when using antennas that range in effective capacitance from 50 to 200 micro-microfarads. However, satisfactory performance will be obtained on practically

any type of mast, fixed, or trailing wire antenna. In extreme cases such as very short mast or very long trailing wire, optimum setting of the antenna alignment control may not be obtained. In general, the most effective antenna is the one farthest away from the grounded metal fuselage. Locate the receiver as near as possible to the lead-in insulator and connect it from the insulator to the antenna binding post "A" by a copper wire. Make sure the lead has enough slack to prevent vibration being transmitted to the receiver.

2. PREPARATION FOR USE.

This receiver is a self-contained unit, having its high-voltage power supply and all coil sets built in. *Before installing the tubes, check them with the required tube checker. Be sure that the proper tubes are installed, are well pushed down and firmly seated in their sockets, that the tube shield is properly seated, and that grid caps fit tightly on the tubes.*

Check dial lights and fuse and see that they are properly and securely placed. Make sure the leads to the dynamotor are properly connected at the dynamotor terminal strip and that the screws holding them in place are tight. With the receiver AVC-OFF-MVC switch in the MVC position and the band switch on band 2, tune in a signal by means of the tuning control at approximately 3.5 megacycles to maximum signal strength. Reduce volume by means of the volume control knob until the signal is just audible. Adjust the antenna alignment control to give maximum volume.

SECTION III OPERATION

1. GENERAL PROCEDURE.

a. POWER SWITCH.—Power to the receiver is controlled by the receiver AVC-OFF-MVC switch. With this switch in the OFF position, no power is supplied to the receiver. When switched to either the MVC or AVC position, power from the primary source is supplied to the tube heaters and dynamotor, thus placing the equipment in operation. The screen-grid voltage-supply leads are carried out of the receiver through the power plug to the keying relay of the associated transmitter where the circuit is opened when actually transmitting as discussed in section II, paragraph 1*c*.

b. OPERATING TEST.—When the receiver has been completely installed, make an operating test as follows:

(1) Plug a headset into one of the jacks marked TEL. Set receiver switch to MVC. After the tubes have warmed up (approximately 30 seconds), advance the volume-control knob until a slight background noise is heard. Set the band switch to the frequency band in which test signals are available.

(2) Using the tuning knob and with reference to the calibrated scale on the dial, tune in the desired signal.

NOTE

All tuning must be done on MVC with the volume control advanced only enough to give the desired signal strength. In the absence of a signal, the setting of the volume control can be judged by the loudness of the background noise. With the volume control set at maximum on MVC, very strong carrier waves will block the receiver and prevent the reception of intelligible signals.

(3) Rotate the receiver switch to AVC. The desired signal should still be heard.

(4) With the beat-frequency adjustment at zero-beat position (arrow on knob pointing up) turn the c-w oscillator switch to the ON position. An audible beat-note, which will vary in pitch when the beat-frequency adjustment is changed, should be heard.

(5) With the c-w oscillator still ON, rotate the crystal filter switch to IN. Noise should be greatly reduced. The signal can be tuned out by a much smaller movement of the tuning-control knob than when the

crystal filter switch is in the OUT position.

(6) Turn the dial light rheostat and see if the functioning of the dial lights controls the illumination.

(7) Make a check before flight with the airplane engine running. An increase of background noise when the engine starts indicates imperfect shielding, bonding, faulty generator regulator, faulty generator, open filter capacitors, or a combination of these faults.

(8) Always turn the receiver switch to the OFF position when the receiver is not to be used.

c. OPERATING ROUTINE.

(1) CONTROLS.

(*a*) ANTENNA AND GROUND BINDING POSTS. — The antenna is connected to the binding post marked A and the ground lead to the binding post marked G.

(*b*) ANTENNA ALIGNMENT CONTROL.— This control varies a capacitor for aligning the input circuit to a given antenna. Make this adjustment with the receiver tuned to approximately 3.5 megacycles.

(*c*) TUNING CONTROL.—This control varies the setting of the four-gang, variable-tuning capacitor.

(*d*) BAND SWITCH CONTROL.—This control selects the desired frequency band as indicated on the dial mask.

(*e*) DIAL LIGHTS CONTROL. — This knob controls the intensity of dial illumination and is provided with an off position.

(*f*) C-W OSCILLATOR SWITCH.—This toggle switch controls the operation of the c-w oscillator as well as the avc time constant for c-w reception.

(*g*) CRYSTAL FILTER SWITCH.—This control permits the insertion of an i-f crystal filter when extreme selectivity is desired.

(*b*) BEAT FREQUENCY CONTROL. — This control permits vernier adjustment of the c-w oscillator frequency and in tuning should be set near the zero-beat position (arrow on knob pointing up).

(*i*) VOLUME CONTROL.—This control is for sensitivity adjustment on MVC operation and output level adjustment on AVC operation. When switching from MVC to AVC, or vice versa, it will generally be

necessary to readjust this control to maintain a given volume level as only under certain conditions of signal strength will the volume level remain unchanged.

(j) AVC-OFF-MVC SWITCH. — This three-position switch in the OFF position removes all power from the receiver. In the MVC position the receiver is operative with manual volume control while in the AVC position the automatic volume control is functioning.

(k) TELEPHONE JACKS.—These are open circuit jacks providing connections to the headset.

(2) MODULATED SIGNAL RECEPTION.

(a) Throw the AVC-OFF-MVC switch to MVC and set other switches and controls as follows: C.W. OSC to OFF and CRYSTAL to OUT. Set the antenna alignment as in section II, paragraph 13.

(b) Set the band switch to the desired frequency band and adjust the tuning control to the desired frequency. It is of great importance that this tuning be accomplished with the receiver switch in the MVC position.

NOTE

Do not use the AVC position while tuning in a signal. Always tune with the receiver switch in the MVC position and with the volume control advanced only as far as required for a comfortable output level.

(c) Increase the volume control until the desired signal is heard or the background noise attains a fair level.

(d) Adjust the tuning control until maximum output from the desired signal is obtained. This insures correct alignment or proper tuning of the receiver.

(e) If automatic volume control is desired, switch to the AVC position and readjust the volume control for the desired output level.

(3) C-W RECEPTION.

(a) The procedure is the same as outlined above except that the c-w oscillator switch is ON and tuning is accomplished with the beat frequency control set near the zero beat position (arrow on knob pointing up).

(b) After tuning in the desired signal the beat frequency control may be varied and the frequency of the beat note adjusted as desired.

(c) Use automatic volume control for c-w reception by switching to the AVC position and readjusting the volume control.

(d) When extreme selectivity is desired to minimize interference, switch the crystal filter to IN. A slight readjustment of the tuning, beat frequency, and volume controls may be required to secure the desired beat-note frequency and volume level.

NOTE

The crystal band pass filter is intended primarily for use in c-w reception. However, the added selectivity may at times prove helpful in receiving modulated signals through heavy interference.

SECTION IV MECHANICAL AND ELECTRICAL CHARACTERISTICS

1. CIRCUITS.

Electrically, the receiver comprises two stages of tuned radio-frequency amplification preceding the first detector, a temperature-compensated heterodyne oscillator, three intermediate-frequency amplifier stages, a second detector and one stage of audio-frequency amplification with a transformer output circuit. A crystal band-pass filter and beat-frequency oscillator are also included. The former is for increasing selectivity and the latter for receiving c-w signals. The schematic and wiring diagrams are shown in figures 27, 28, 37, and 38.

2. FREQUENCY RANGE AND FREQUENCY BANDS.

The frequency range of 1.5 to 18.0 megacycles is covered in six bands which are under the control of a band change switch. The frequency range for each of the six bands is given in the following table:

Band	Frequency Range Megacycles
1	0.2— 0.5
2	1.5— 3.5
3	3.5— 6.0
4	6.0— 9.5
5	9.5—13.5
6	13.5—18.0

3. INPUT COUPLING.

The antenna input circuit is capacitively coupled to the first tuned grid circuit by means of the antenna alignment capacitor. Sufficient range is available in this capacitor to permit alignment for antenna capacities within the limits of 50 to 2000 micromicrofarads. The antenna input circuit is designed for antennas with a resistance of 1 to 5 ohms.

4. INPUT PROTECTION.

Resistor 50-1 offers a leakage path for static charges

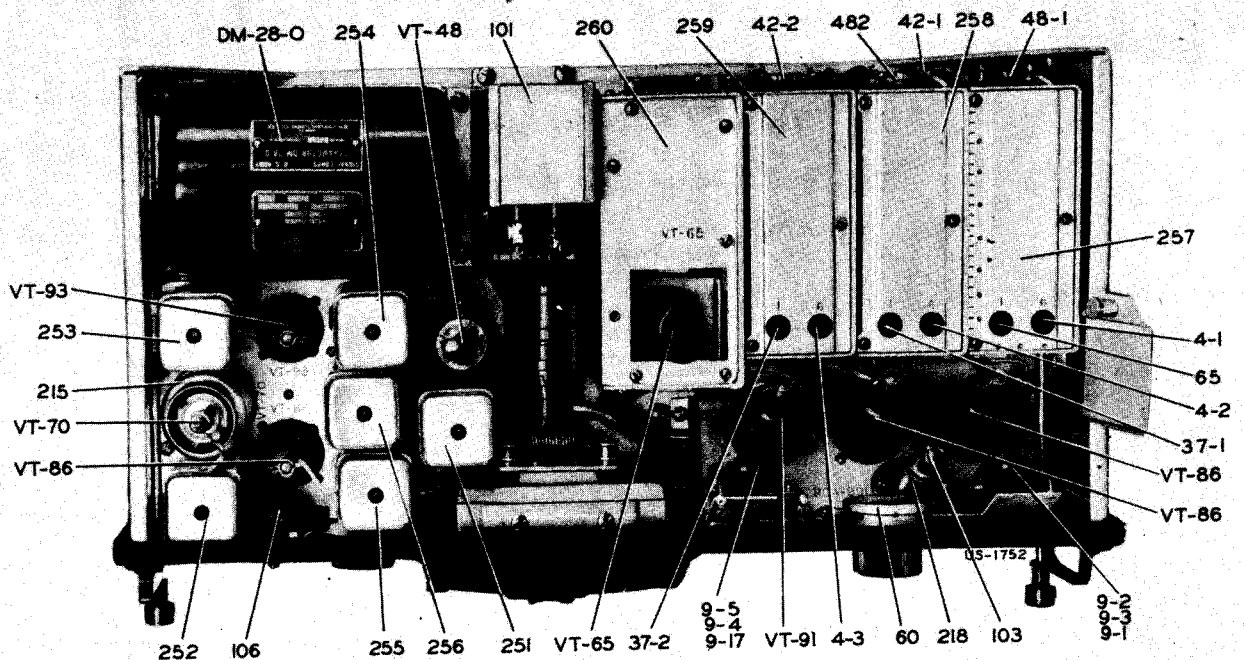

Figure 7 — Radio Receiver BC-348-(*) or BC-224-(*), Top View of Chassis

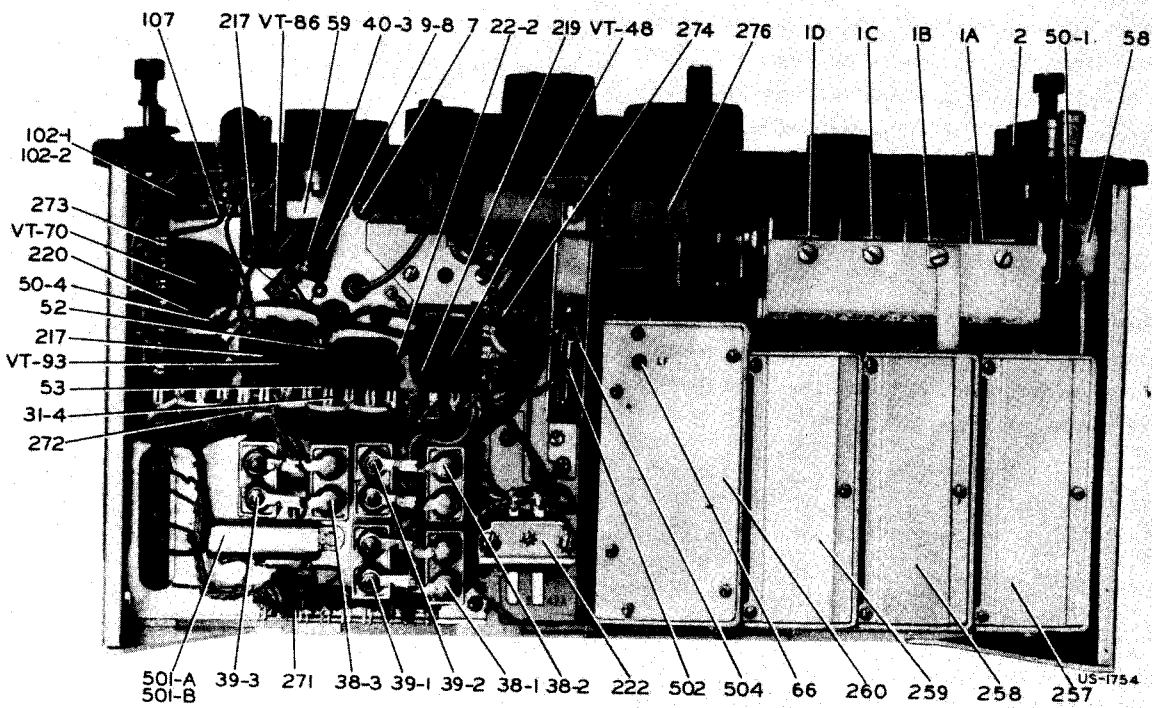

Figure 8 — Radio Receiver BC-348-(*) or BC-224-(*) Bottom View of Chassis

which may be collected on the antenna. The input circuit will withstand the application of 250 volts d-c without damage. For protection against the application of r-f voltages up to 30 volts rms the input circuit provides for the overshooting of the grid of the first r-f tube and the building up of a protective negative grid bias across grid filter resistor 48-1.

5. RADIO-FREQUENCY AMPLIFIER.

The radio-frequency pre-selector comprises three tuned circuits employing two super-control pentode amplifier tubes, Tube VT-86, (JAN-6K7). Separate inductances are employed for each frequency band. The r-f gain of each of the six bands is kept uniform by maintaining the proper turn ratio between the grid and plate circuit for each of the respective bands. A relatively low signal level is maintained at the grid of the first detector tube, thus insuring freedom from cross-modulation interference.

6. FIRST DETECTOR.

The first detector uses Tube VT-91 (JAN-6J7) which has a sharp cutoff characteristic. The low signal level at the grid of the first detector, together with the r-f pre-selection, insures a minimum of undesired responses. The oscillator output is coupled into the cathode circuit of this tube. Separate cathode coupling coils provide optimum oscillator output for each frequency band.

7. HETERODYNE OSCILLATOR.

The heterodyne oscillator employs a tuned grid, plate-feedback circuit, utilizing triode Tube VT-65 (JAN-6C5). On the oscillator frequency the effects of wide variations in ambient temperature under service conditions have been reduced to a minimum by the use of a highly stabilized tuning capacitor and temperature compensation with ceramic fixed capacitors 34, 35, 36 and 64.* Individual inductances and trimmers are employed for each frequency band, and the low-impedance coupling circuit to the cathode of the first detector insures a freedom from frequency instability with load variation or detector circuit tuning. On the four lower frequency tuning bands, the oscillator frequency is higher than the desired signal by the intermediate frequency. On the two higher frequency ranges, bands 5 and 6, the oscillator is on the low-frequency side of the desired signal. This results in a more uniform tuning ratio over these bands and increases the image-rejection ratio.

8. INTERMEDIATE-FREQUENCY AMPLIFIER.

The intermediate-frequency amplifier comprises three

*33, 34, 35 and 36 are used in BC-348-E, BC-348-M, and BC-348-P.

low gain amplifying stages coupled by four highly selective, double-tuned, circuit transformers. The intermediate frequency used is 915 kc, $\pm 0.1\%$. The i-f transformers are tuned by means of adjustable iron cores and fixed capacitors. The increased permeability resulting from the use of the iron cores contributes largely to the highly selective transformer characteristics while the lowered tuned circuit impedance, secured by the relatively large fixed tuning capacitors, provides an inherently stable amplifier. Tube VT-86 (JAN-6K7) functions as the first i-f amplifier while the pentode section of Tube VT-70 (JAN-6F7) is used as the second i-f amplifier. Tube VT-93 (JAN-6B8), the third i-f amplifier, supplies a relatively high-level signal to the diodes of this same tube.

9. C-W OSCILLATOR.

a. The c-w oscillator uses the triode section of Tube VT-70 (JAN-6F7, second i-f amplifier tube) in a tuned-grid, plate-feedback circuit. The adjustable iron core in grid inductance 98 is employed for rough frequency alignment while a small panel-operated variable capacitor permits fine adjustment of the beat frequency within a range of approximately 4000 cycles each side of zero. The effects of ambient temperature variations are minimized by the use of a temperature-compensated tuned circuit. The c-w oscillator operates at an extremely low level, minimizing harmonics and stray oscillator pickup. The output is capacitively coupled to the plate circuit of the second amplifier tube by the coupling lead connected to the oscillator grid. Amplification by the third i-f amplifier stage, the gain of which is not controlled either by manual or avc, provides sufficient output from the c-w oscillator to the diode detector. This value of oscillator output is somewhat below the level at which the avc operates, thus permitting the use of automatic volume control even for c-w reception.

b. The c-w oscillator switch 106 in the ON position supplies the oscillator plate voltage and increases the avc time constant by connecting the additional capacitor 101-C. Switch 106 supplies the oscillator plate voltage by connection to the screen grids of the first and second i-f and first r-f tubes. The same switching connects loading resistor 43-4 which drops the screen voltage on the first and second i-f and the first r-f tubes to a value that reduces the sensitivity by an amount sufficient to keep the overall noise of the set essentially constant. This arrangement for supplying the c-w oscillator has added advantages which are not obvious. In order to have sufficient oscillator excitation available to handle high detector levels encountered with avc operation and strong signal inputs, while still keeping the no signal c-w excitation below the avc delay level, it is de-

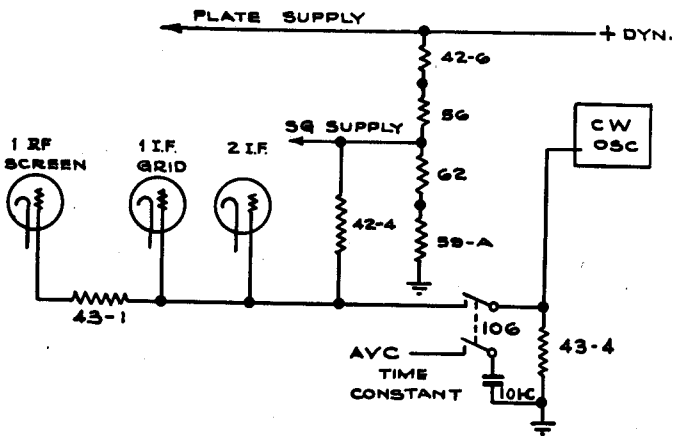

Figure 9 — C-W Oscillator Switching

sirable to have the c-w oscillator output increase as a strong signal input raises the avc bias. The circuit arrangement, as shown in figure 9, accomplishes this as follows: with the AVC-OFF-MVC switch 107 in the AVC position, resistors 42-6, 56, 59-A, and 62 form a fixed bleeder supplying the screen-grid voltage to r-f, 1st detector, and i-f tubes. A strong input signal building up the avc bias causes a considerable decrease in screen current and hence an increase in the screen supply voltage. This increases the voltage supplied to the c-w oscillator and hence the excitation increases in proportion to signal level at the detector.

10. CRYSTAL BAND-PASS FILTER.

Additional selectivity is available by the use of the i-f crystal filter preceding the first i-f amplifier tube. This crystal filter comprises a balanced capacity bridge circuit which may be adjusted internally to provide a band width of 800 to 3000 cycles at 20 decibels down from resonance. The tapped tuned circuit (19 and 96) matches the impedance of the crystal bridge to the 1st i-f grid. The crystal filter may be switched in or out of the circuit by CRYSTAL OUT-IN switch 105, actuated from the front panel. The filter band width is adjustable by balancing capacitor 7. The band width is set at approximately 2000 cycles. For adjustment see paragraph 8c of section V.

11. SECOND DETECTOR AND AUTOMATIC VOLUME CONTROL.

Tube VT-93 (JAN-6B8) also functions as the second detector. A relatively high level signal is supplied by the third i-f amplifier to the diodes of this tube. One diode functions as the signal linear detector while the other

diode is capacity coupled and provides high level delayed avc control bias.

12. OUTPUT.

a. DESCRIPTION.—The high-level signal diode supplies audio output for driving output Tube VT-48 (JAN-41) without additional audio amplification. The design choice of three i-f amplifier stages and high level detection results in a number of operating advantages. The high level detection is relatively free from distortion due to avoiding the characteristic curvature at the lower end of the diode curve. The direct drive of the output tube from the diode detector simplifies the dynamotor ripple filtering and eliminates possible microphonics resulting from high audio amplification. The high diode level further provides relatively high bias voltage insuring an unusually flat automatic volume control characteristic with the desired time delay. The dual volume control comprises potentiometers 59-A and 59-B. Potentiometer 59-B functions only with switch 107 in the AVC position and, in this position, it permits the desired adjustment of the audio level to the output tube and load. For manual volume control with switch 107 in the MVC position, potentiometer 59-A becomes the active control operating on the cathode bias of the r-f and the 1st and 2nd i-f amplifier tubes. These potentiometers have two linear resistance tapers providing a smooth variation of sensitivity. Automatic load compensation is obtained by the method of biasing the output tube. Here, the grid bias is obtained from the resistance drop across the dynamotor filter reactor, thus, any tendency towards a decreasing load on the dynamotor results in a slight decrease in the bias of the output tube with a compensating increase in the load current. (See fig. 11.) Tube VT-48 (JAN-41) provides a considerable margin of power capability above that necessary to operate a number of headsets in parallel.

b. CONSTANT INTERNAL RECEIVER NOISE.—The characteristic increase of internal receiver noise when tuning from the low to the high-frequency end of

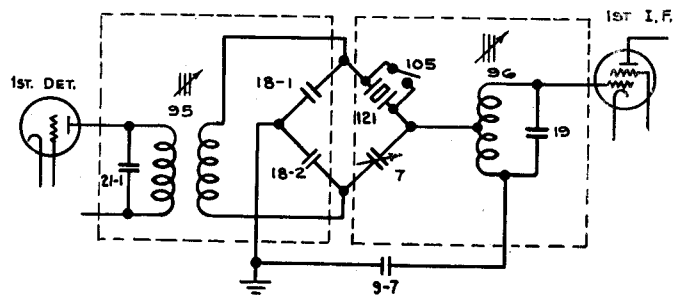

Figure 10 — Details of Crystal Filter Circuit

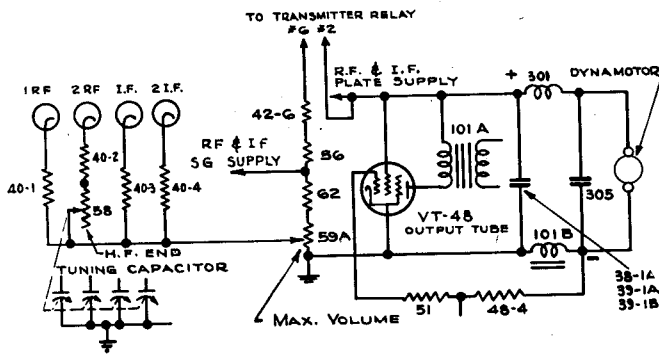

Figure 11 — Load Compensator and Bleeder Circuit Details

a band has been reduced in this design by means of variable resistor 58. The function of this potentiometer can be more clearly understood by reference to figure 11. Here, the noise compensator potentiometer 58 is mechanically connected to the shaft of the ganged tuning capacitor with the electrical connections such as to give minimum resistance at the low-frequency end of the band. The cathode return lead of the second r-f amplifier tube connects to the noise compensator potentiometer 58 and hence the gain of this stage is decreased proportionately as the tuned r-f circuit impedance increases when tuning toward the higher frequency end of each band. This arrangement tends to maintain the noise level and receiver sensitivity essentially constant over the tuning ranges.

c. OUTPUT IMPEDANCE. — This receiver is furnished with an audio output transformer which permits operation into a wide range of load impedance (see fig. 12). With the receiver as normally supplied, the audio output connection is made to terminal #4 of the audio pack (transformer 101A). This is the proper connection for load impedances from 1000 to 10,000 ohms with optimum operation at a load impedance of 4000 ohms. To operate the receiver with a load impedance of 300 ohms the audio output lead should be removed from terminal #4 and soldered to terminal #2 on the audio pack. This is the proper connection for load impedances from 75 to 800 ohms.

13. DYNAMOTOR.

The dynamotor and associated r-f filter circuits are assembled in one unit. The r-f filters are of the unbalanced type for use with a primary supply in which the

negative side is grounded. This dynamotor supplies all of the high-voltage direct current required for the operation of the receiver and, in addition, a maximum of 20 milliampères for use in operating accessory equipment.

NOTE

The dowel pin on the chassis of 28-volt receivers, which fits into the hole in the dynamotor mounting base, prevents accidental installation of 14-volt dynamotors in 28-volt receivers.

14. DIAL AND MASK ASSEMBLY.

The dial and mask assembly is mounted on an aluminum casting which carries the gearing of the tuning capacitor drive and the detent. This unit is attached to the front panel and connects to the band switch drive shaft through a coupling of the Oldham type. The dial is divided into six frequency bands, and the dial and tuning capacitor are so geared to the tuning control shaft that the tuning capacitor covers the frequency range indicated on the dial for each band in approximately 90 revolutions of the tuning knob. Split gearing is used throughout to minimize backlash. A positive stop is provided to prevent undue pressure on the gears and to limit the travel of the dial and the tuning capacitor. A mask with suitably located and marked windows is mounted before the dial. The mask is controlled by the band change switch and is positioned by the detent.

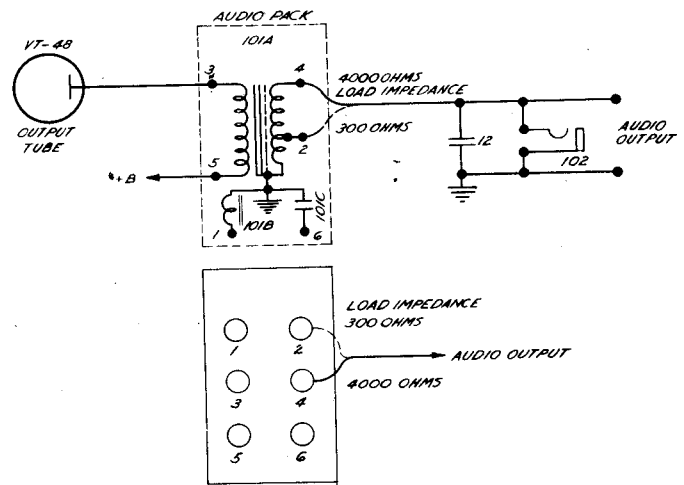

Figure 12 — Details of Output Transformer Connections

SECTION V MAINTENANCE

NOTE

Use a standard signal generator, a phantom antenna, Test Set I-56-A, and other like equipment for alignment purposes and follow the instructions in this book carefully.

1. INSPECTION.

a. DAILY. — Turn on receiver. Check dial lamps. Check for operation on all bands with c-w oscillator on. Make this test by observing noise level with volume control at maximum.

b. 25 HOURS.—Repeat the above with an additional check of antenna, ground and cable connections for effects of vibration.

c. 100 HOURS.—Repeat the above with an additional check of all vacuum tubes, regulator tube and dial lamps. Inspect receiver for loose grid clips, tube shield, etc. Inspect all tubes with model 685 type 2, tube checker of Test Set I-56-A.

d. MAJOR OVERHAUL.—Repeat the above with inspection and replacement of dynamotor brushes, if necessary. Lubricate dial and tuning condenser drive mechanism. Check dynamotor and tube socket voltages as described in paragraph 8c (1) and (3), this section.

2. REPLACEMENT OF DIAL LAMPS AND FUSES.

a. DIAL LAMPS.—Unscrew #205 thumb screw on right and left of dial lamp housing and remove the housing, thereby exposing the lamps. The bulbs are of the bayonet base type. Remove by lightly pressing down on the top of the bulb and turning slightly to the right. Then, lift out and replace by inserting the new bulb into the socket, pressing down lightly and turning to the left. Change both bulbs when either one burns out.

b. FUSES.—Remove the chassis from its case and if a visual inspection does not reveal the cause of a blown fuse, make a thorough electrical test before replacement. The fuse is of the small glass cartridge type located

at the center of the chassis on the bottom. Remove the old fuse by lifting it out of the spring clips and replacing with a new fuse rated at 5 amperes in the same clips.

3. CARE AND SERVICING OF DYNAMOTOR.

a. PROCEDURE FOR REMOVAL. — Follow this procedure to remove the dynamotor and filter assembly from the receiver chassis:

(1) Loosen the two thumb screws on the receiver panel and draw the chassis from the cabinet.

(2) Lay the chassis with top upwards on a smooth, flat surface with the rear toward the operator.

(3) Depress the retaining spring and withdraw the left thumb screw rod.

(4) Loosen the five connector screws on the dynamotor terminal strip and withdraw the spade terminals from beneath them.

(5) Loosen the four captive screws 211, figure 13, which hold the dynamotor unit to the chassis.

(6) Remove the dynamotor and filter assembly from the receiver by grasping the dynamotor and lifting vertically.

(7) The filter portion of the dynamotor unit is made accessible by the removal of the cover at the bottom. See figure 13.

b. LUBRICATION.—This dynamotor requires lubrication after 1000 hours or approximately 6 months of ordinary service. Lubricate only with Air Corps grade 375 grease. The directions for lubrication are stamped on the inside of the end-bell dust covers. Access to the bearings of the dynamotor is obtained by removing the dust covers after first cutting the safety wires and removing the retaining screws, then unscrewing the bearing end plates. Do not PACK the lubricant in these bearings.

c. SERVICING BALL BEARINGS AND COMMUTATORS.—When necessary to replace the ball bearings or turn down the commutators, first remove the brushes from their cartridges. Remove the nuts from the tie rods

which hold the bearing end-bells and pull the end-bells away from the field coil assembly. Now take out the armature. Examine the brushes to see that they have worn properly and are free from hard spots. Should such spots be apparent (they generally cause grooves in the commutator surface), replace the brush and smooth down the commutator. The ball bearing retainers and the shaft are machined for very snug fits, but a slight tapping will loosen them. To remove the bearing retainers

from the end-bells use two small screwdrivers as wedges between the outer ball race and the end-bell. If the grease slinger becomes bent during removal, straighten and replace on the shaft before replacing the bearing.

d. SMOOTHING THE COMMUTATOR. — To smooth the commutator rotate it in a lathe holding a fine grade of sandpaper, not coarser than size 00, lightly against the commutator surface. Do not use emery cloth.

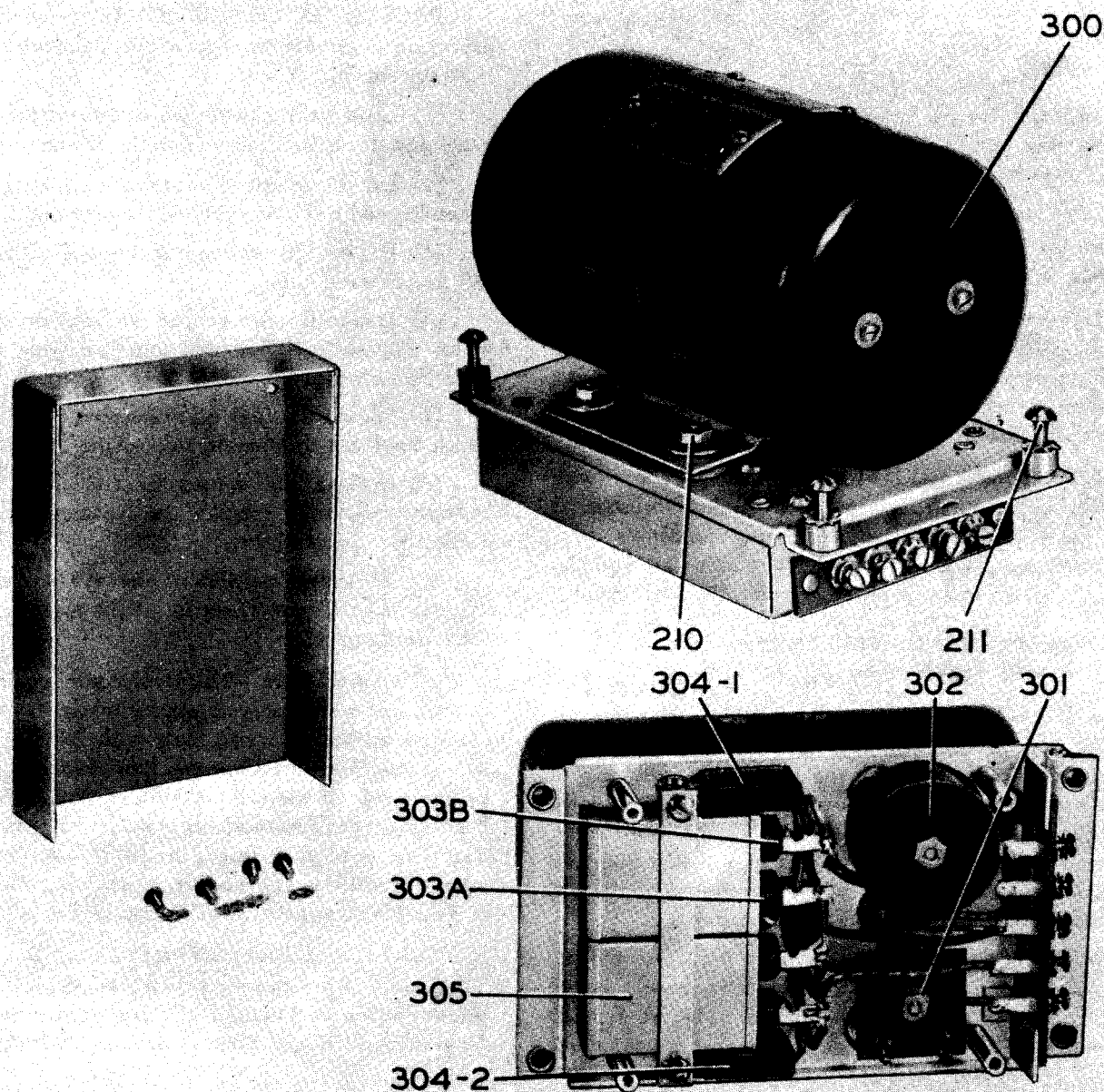

Figure 13 — Dynamotor DM-28-(*) or DM-24-(*), View Showing Filter Open

Wipe away all residue of dust, sand and dirt leaving a clean, smooth, polished commutator surface. Never sand or turn down a commutator having a smooth or polished surface simply because it is discolored. If the commutator is turned down in a lathe, the mica segment separators must be undercut.

e. REASSEMBLY OF THE DYNAMOTOR.—This is accomplished in substantially the reverse of the disassembly procedure except that the use of the screwdrivers as wedges is not necessary. In replacing the brushes, check to see that the + and - markings on the brushes correspond with those on the brush holder supports, and that the marked side of the brush is towards the top of the dynamotor. Give the commutator a final inspection for free running, cleanliness and absence

of grease or oil. Wipe the end-bells clean and dry before replacing them on the dynamotor.

f. NOMINAL RATINGS.—The nominal ratings of 14-volt dynamotors are input, 2.45 amperes at 13.8 volts; output, 70 milliamperes at 220 volts; regulation 12 per cent. The nominal ratings of 28-volt dynamotors are input, 1.23 amperes at 27.9 volts; output, 70 milliamperes at 220 volts; regulation 12 per cent.

4. REMOVAL OF FRONT PANEL

a. For adjustment of dial or mask, or for servicing of certain parts, it may become necessary to remove the panel. Take the chassis with the panel attached, out of the cabinet and place for inspection with the panel facing upwards. Unsolder the lead to the antenna binding

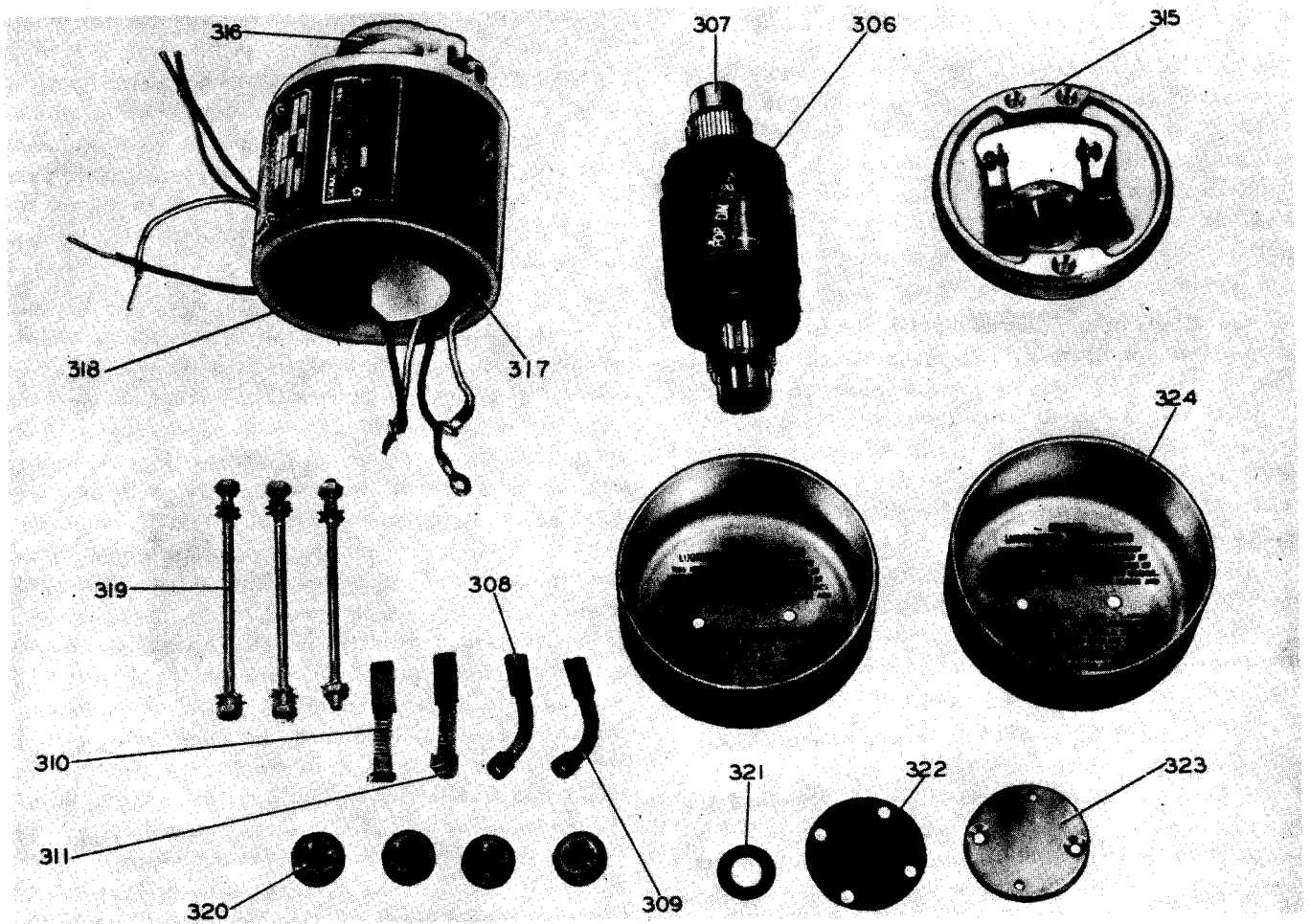

Figure 14 — Dynamotor DM-28-(*) or DM-24-(*), Disassembled

post and the lead from the chassis to the dial lights. Remove the dial light housing cover, the two thumb screw rods, the handles, and all knobs and retaining nuts of all controls except the DIAL LIGHTS control. Also, remove the retaining nuts of the TEL jacks. The panel may be lifted off after the removal of the end plate holding screws, the chassis holding screws, the dial casting holding screws and a screw which supports the crystal filter assembly to the panel.

b. In replacing the BEAT FREQ control knob turn the flexible shaft until the set screw in the coupling at the internal end points away from the panel. Now mount the knob so that the arrow points vertically towards the top of the receiver. This knob has two set screws. In replacing the other knobs on the shafts, note that flats on the shafts provide for proper location. Securely tighten all set screws and give the set screw on the band switch knob in particular, a second tightening after the shaft has been rotated a few times.

5. DIAL AND MASK ASSEMBLY.

a. GENERAL.—Attached to the front panel, and to the main frame or chassis casting is an aluminum casting which is the frame for the switch drive shaft, dial mask and detent, and also for the tuning dial, tuning shaft, reduction gears and stop. All of these parts are assembled and can be moved as a unit, thus simplifying any service operations which might be required.

b. SWITCH DRIVE SHAFT. — This shaft passes through a hole in an adjustable plate located in the dial lamp housing and through a clearance hole in the panel. The hole in the adjustable plate is purposely given a larger clearance than bearing requirements would dictate since its use is to support the shaft against forces which might spring it or damage the internal bearing. At the inside end of the shaft, the detent (star wheel) and the driving portion of the coupling member are pinned in place by means of taper pins. The shaft extends through a long bushing pressed in the dial housing. The dial assembly runs on the outside surface of the long bushing referred to above. The hub of the mask is attached to the shaft by a taper pin just inside the panel.

c. STOP-ARM ASSEMBLY.—On the back of the dial frame casting is a stop-arm which engages a pin in the detent so as to limit its rotation to 6 positions which are spaced 60 degrees apart. There is attached to the assembly of pivot pins, arms with rollers, and a spring which positions the detent. This assembly is locked with two dowel pins after the correct location is made.

d. INDEX PLATE.—On the front (panel) end of the bushing through which the switch shaft passes there is a

narrow groove which positions the lower end of the index plate. This plate is attached to the casting at its upper end with means for removing any slack and keeping it straight. The index plate has a keyhole-shaped opening to permit it to be placed in the groove. The outer end of the dial hub turns and is held against the rear surface of the index plate.

e. DIAL HUB.—The dial is attached to a flange on a hub which runs on the outside surface of the bushing through which the switch drive shaft passes. This hub also carries a large gear which is driven by a pinion combined with a split-idler gear. This split-idler gear and pinion has an adjustment in the clearance holes for the mounting screws to enable the backlash in the mesh of the pinion with the large dial gear to be reduced to a minimum.

f. SHAFTS.—The tuning shaft has, in addition to the pinion referred to above, a stop, and a worm which meshes with a split worm gear on a cross shaft at the back of the frame. Both this cross shaft and the tuning shaft run in bearings which are integral in the casting. Both shafts have spring thrust washers to remove end play. The cross shaft carries a pinion which is meshed with a split gear on the tuning capacitor shaft assembly. The degree of mesh of this pinion and gear is adjustable by moving the tuning capacitor toward or away from the panel after it is placed in position and before the holding screws are finally tightened.

g. GEAR RATIO.—The overall gear ratio between the tuning shaft and the capacitor shaft is 200 to 1. Since the design of the tuning capacitor permits but a small amount of rotation at either end of its travel beyond the 180 degrees required to give its complete range in electrical capacity, means are provided to stop the tuning shaft at either end of a total of approximately 100 revolutions. This is accomplished by a cam on the outer edge of the tuning dial which operates an arm pivoted on a pin on the frame casting. One end of this arm has a roller which runs on the outer edge of the dial. The roller is held in contact with the dial by a spring. A cutout is positioned in the edge of the dial in such a manner that, when the point corresponding to either end of the tuning capacitor travel is reached, the roller, and therefore the end of the arm, can move toward the center of the dial, being forced in that direction by the spring. Thus, the opposite end of the stop arm is moved so that the hook at the end of the arm engages the rotating stop on the tuning shaft and the shaft is thereby prevented from further turning. When the direction of rotation of the tuning shaft is reversed, the roller and arm are pushed outward against the spring by the cam edge of the dial and the stop disengages.

b. **DIAL CALIBRATION.**—Since a definite relation must be set and maintained between the dial position and the angular position of the rotor of the tuning capacitor, adjustment is provided at the pinion on the cross shaft at the rear of the frame. (This is the shaft which also carries the worm gear.) This pinion is held in place by two set screws which bear in a groove on the shaft. By loosening these two set screws, either the dial or the tuning capacitor can be rotated while the other part remains fixed. The correct relation between these is that the tuning capacitor rotor plates are fully meshed with the stator plates (maximum capacity) when the dial is set against the stop at the extreme low frequency end of the tuning range.

6. REMOVAL AND REPLACEMENT OF DIAL MECHANISM.

a. **GENERAL.**—To remove the dial mechanism from the chassis for any servicing operations, first remove the front panel in accordance with instructions given in paragraph 4 of this section. The frame of the mechanism is attached to the chassis by the bracket holding the fuse, and by two slotted hexagon head screws through the flange on the under side of the chassis. Note that one of these screws is beneath the removable shield which covers the terminal of the first i-f transformer. When these screws are removed, the complete unit can be removed. The center disc of the flexible coupling is loose and will drop out of engagement.

b. **PROCEDURE.**—To remove the index and dial, remove the taper pin holding the mask hub to the switch drive shaft. It is necessary to support the shaft when driving out this pin so that excess stress will not be placed on the center bushing. After the removal of the mask and the index, the dial and its gear are free to slide off the bushing. In replacing these parts, the thrust washer behind the dial hub must be turned in the position to give maximum thrust (convex side outward).

c. **READJUSTMENT.**—If the dial is removed and replaced, it is possible that, in meshing the dial gear with the idler gear, the stop relationship may not be correct, in which case it may be necessary to change the engagement of the gears a tooth at a time. The stop relationship must be such that the roller arm hook and the tuning shaft stop arm engage fully at the end of the last revolution, but on the previous revolution the arm must not start to move until after the rotating arm has passed under the roller arm hook. This adjustment can only be made by trial and inspection, but it can be secured in one or two trials. Substitution of a different stop arm may also require readjustment, but in this case make the adjustment by lengthening or shortening the

roller end of the arm. This is done by loosening the two nuts on the arm, after which the arm can be adjusted by the slotted holes provided.

d. **MASK SETTING.**—When the dial mechanism is replaced, properly position the flexible coupling so that the position of the mask corresponds to the switch position, since it is impossible otherwise to get the band switches to an inoperative position. The correct relative positions are obtained when the mask is set to band 200-500 kc and the set screw locking the flat switch shaft to the large bevel gear hub is 15 degrees back (away from panel) from vertical.

e. **REMOVAL OF BACKLASH.**—If any of the gear trains including split gears have been unmeshed in disassembly, reset the split gears to put tension on the loose section when they are again meshed. Normally, a displacement of one tooth between the two sections is sufficient. Trial will show whether this will remove the backlash.

f. **FINAL ADJUSTMENT.**—When the dial mechanism is reassembled to the chassis, carefully adjust the relationship between the dial and the tuning capacitor in order to maintain the calibration and prevent over-running the capacitor (refer to par. 5b of this section.) This is done by loosening the two set screws in the pinion on the cross shaft on the back of the dial assembly. Before putting the mechanism in place, this pinion can be moved along the shaft toward the worm gear so as to clear the capacitor split gear. This facilitates assembly since the gears can be meshed after the dial mechanism is bolted in place, making it easier to get the tension on the split gear in the capacitor assembly.

7. REMOVAL OF ANTENNA, R-F, DETECTOR AND OSCILLATOR UNITS.

(See figs. 19, 20, 21, and 22)

In many cases servicing of these units will require only the removal of the top or bottom cover of a particular unit. However, any unit may be removed and replaced independently as follows:

a. Unsolder the lead to the main tuning capacitor at the capacitor by first removing the capacitor shield. Unsolder all other leads at the unit.

b. Disconnect the band switch drive shaft and withdraw from the antenna unit end.

c. In the case of the antenna unit, disconnect the antenna alignment control shaft.

d. Remove screws holding the unit to the tie strips at the bottom.

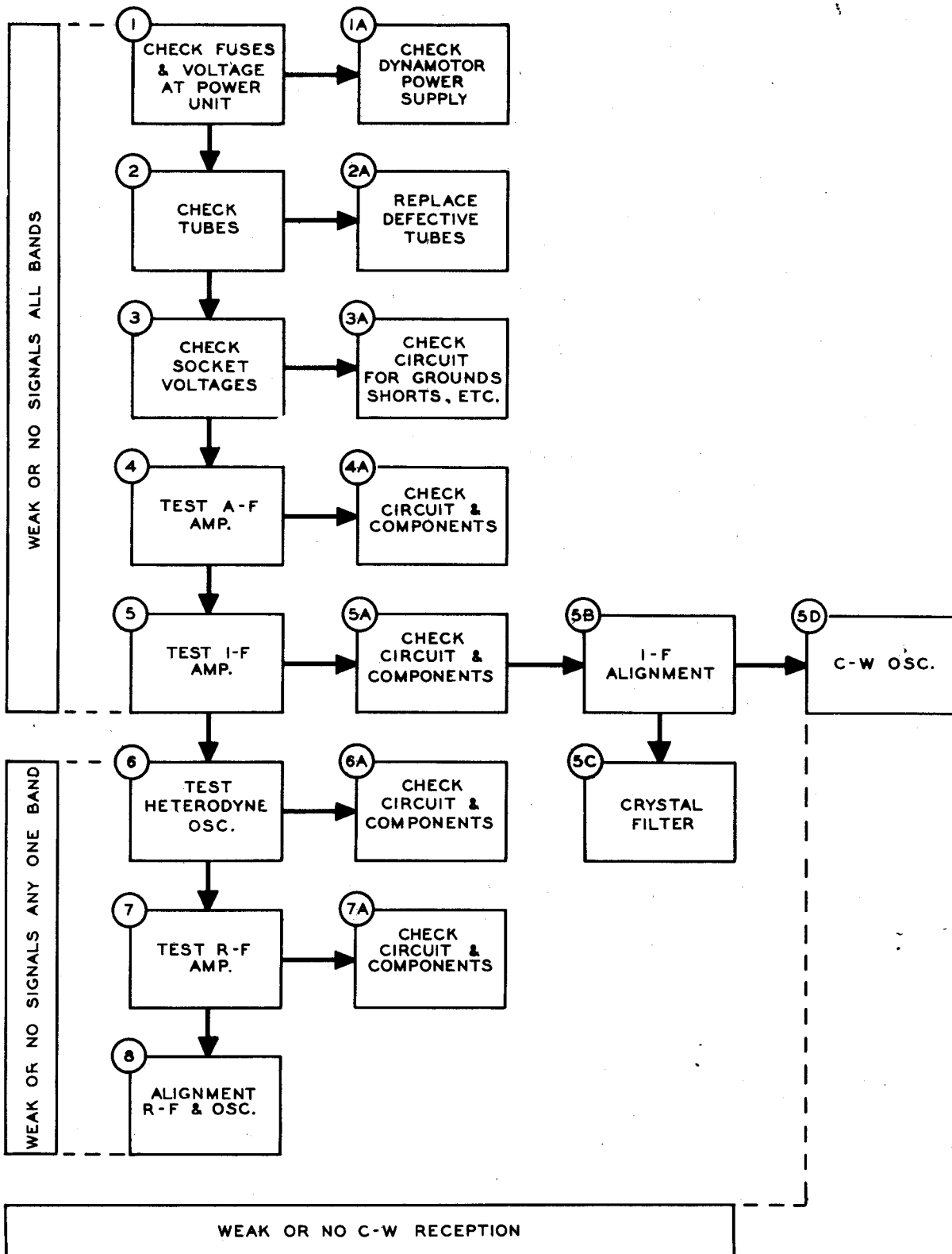

Figure 15 — Trouble Location and Correction Chart

- e. Remove screws holding the unit to the chassis.
- f. Lift the unit from the receiver, taking care that it comes out freely.

When replacing a unit, reverse the procedure above. However, do not completely tighten the screws holding the chassis until the drive shaft has been replaced and the band change switch knob has been rotated a number of times. This will insure the self-alignment of the unit and the proper action of the detent.

8. TROUBLE LOCATION AND REMEDY.

a. GENERAL.—The sensitivity (number of microvolts input to produce 10 milliwatts output into the normal resistance load) of the receiver should not be more than 9 microvolts when measured under the following conditions:

- (1) AVC-OFF-MVC switch at MVC.
- (2) 28 volts input or 14 volts depending upon the power supply and set used.
- (3) CRYSTAL filter OUT.
- (4) Output load, non-inductive resistance of 4000 ohms.
- (5) Pure c-w input from signal generator applied between antenna-ground terminals through a 100-mmf dummy antenna.
- (6) Volume control set to produce a 0.3 milliwatt noise output.

This sensitivity will, of course, be subject to variation with time due to tube aging, etc. Make major adjustments and repairs only in an authorized repair shop equipped with the necessary servicing tools and equipment.

NOTE

Unauthorized personnel must refrain from changing any of the adjustments of the radio-frequency circuits.

The difficulties usually experienced are the result of external deteriorating influences, such as worn-out vacuum tubes, improper operating voltage, blown fuse, external noises, etc. However, in order to permit the servicing of this equipment, follow the testing procedure shown in determining the sources of trouble.

b. EQUIPMENT REQUIRED. — Few instruments other than those found in a standard set analyzer (Test Set I-56-A) are required in locating the most probable troubles in this receiver. The individual instruments required are as follows:

- (1) A modulated test oscillator (standard signal generator) with a frequency range from 200 to 18,000 kc with provisions for calibration accuracy better than 0.1 per cent at aligning frequencies.
- (2) Voltmeter*—1000 ohms per volt, ranges 0-10, 1-100, 0-250 volts.
- (3) Continuity tester*.
- (4) Output meter rectifier type*—0-15 volts, 4000 ohms.
- (5) Microammeter—0-200 microamperes.
- (6) Audio frequency oscillator.
- (7) Pair of telephone receivers.
- (8) Adaptor FT-211 consisting of an eight-prong octal plug and an eight-prong octal socket connected together by a short length of eight-conductor cable to permit use of Test Set I-56-A analyzer on the r-f tubes on the tube shelf.

c. WEAK OR NO SIGNALS ON ALL BANDS, MODULATED RECEPTION.

(1) CHECK OF DYNAMOTOR VOLTAGES.—When all signals on all bands are weak or no signals are heard when known to be present, follow the procedure shown in the chart. The voltages checked at the dynamotor terminal board should closely approximate the values shown in figure 16. Conditions of measurement are as follows:

- (a) Input voltage 28 volts for BC-348-(★) or 14 volts for BC-224-(★).
- (b) CRYSTAL OUT.
- (c) MVC.
- (d) Volume max.
- (e) C.W. OSC. OFF.
- (f) Load resistance (see par. 12c of section IV.)

If these voltage readings do not approximate the values shown, check the fuse as well as the dynamotor and filter circuits, wiring and components.

(2) TUBE CHECK.—If the voltages at the dynamotor terminal board approximate the values given, proceed to check all tubes for emission and characteristics or replace all tubes with those of known average characteristics.

* Part of Test Set I-56-A.

(3) CHECK OF SOCKET VOLTAGES.—If tubes check satisfactorily, or if, after replacing with tubes known to be good, the sensitivity is still low, proceed to check all tube socket voltages with Test Set I-56-A as outlined in paragraph 14f. The average socket voltages are given in figure 16.

(4) CHECK CIRCUIT WIRING AND COMPONENTS.—If the tube socket voltages do not approximate the values shown in figure 16, check the associated circuits and components for grounds, shorts and similar defects.

(5) TEST OF AUDIO-FREQUENCY AMPLIFIER.—Having checked all socket voltages and found the values to be correct, proceed to the test of the audio frequency amplifier. This can be checked by capacitively coupling a 400-cycle voltage of approximately 2 volts rms between ground and the detector diode socket prong using a capacitor of 0.5 mfd. As an alternative, a modulated 915-kc signal of 2 volts may be coupled to this point and ground. Proper functioning of the audio amplifier will be indicated by an output well over 10 milliwatts for the 2-volt audio input or approximately 1 milliwatt output for 915-kc input. Check circuits, wiring and components if this order of response is not obtained.

(6) TEST OF I-F AMPLIFIER.—Following a satisfactory test of the audio amplifier, check the inter-

mediate frequency amplifier by capacitively coupling the modulated test oscillator to the grid cap of the first detector tube and ground through a 0.1-mfd capacitor, the frequency being adjusted to 915 kc. A rough check of the proper functioning of the i-f amplifier indicates a comfortable headphone output level with low input from the test oscillator. (Approximately 25 microvolts input for 10 milliwatts output.)

(7) I-F AMPLIFIER CIRCUIT CHECK.—If the i-f amplifier does not respond as above or lacks sensitivity, make a progressive check, stage by stage. The test oscillator, 915-kc modulated input, is connected through a 0.1-mfd capacitor to the second detector diode socket prong and to ground. A signal response indicates proper functioning. Coupling the test oscillator to the grid of the third i-f should indicate a decided gain in sensitivity. Proceeding similarly towards the first detector, each stage should show a decided gain, and a faulty stage can be circuit-checked for grounds, short, or defective components.

(8) I-F AMPLIFIER ALIGNMENT CHECK. — When all stages have been tested, check the i-f amplifier alignment by capacitively coupling a low level input signal of 915 kc $\pm 0.1\%$ to the first detector grid. Adjust the frequency of this alignment signal to that of the crystal filter of the receiver under test by switching

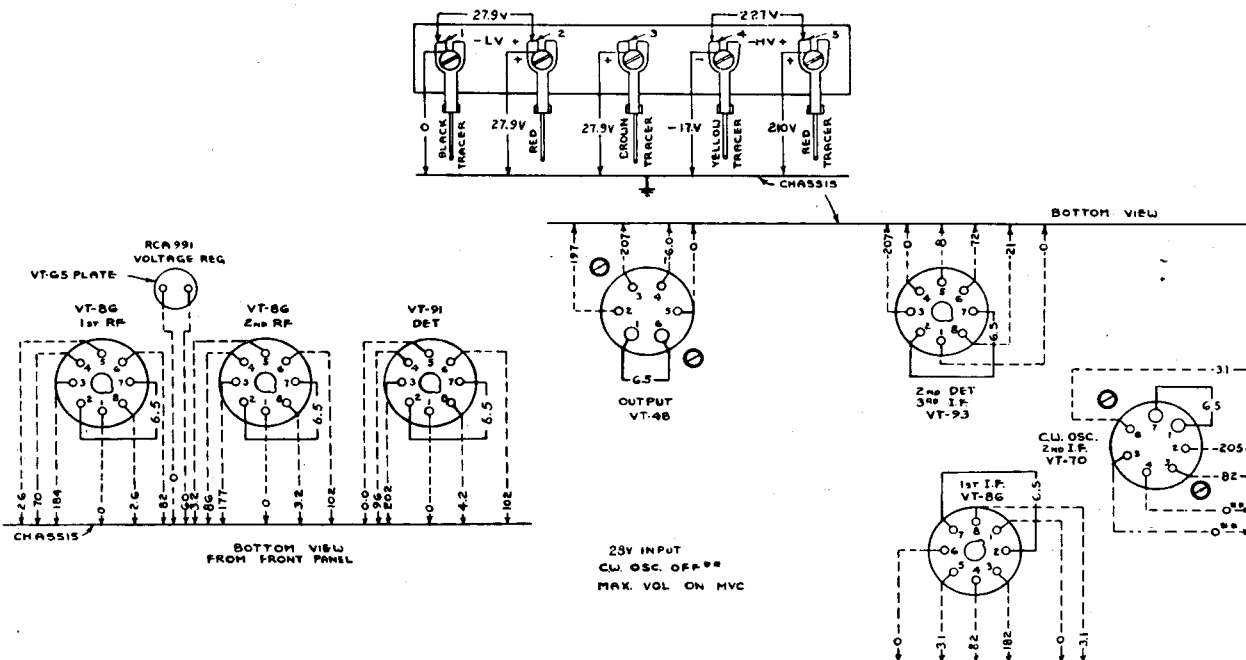

Figure 16 — Radio Receiver BC-348-(*)
Dynamotor and Tube Socket Voltages

the crystal filter switch IN and adjusting the test signal frequency for maximum response. The crystal filter is then switched OUT. For normal alignment procedure, the i-f tuning cores of both primary and secondary windings of the first, second, and third i-f transformers and the tuned circuit of the crystal filter assembly are adjusted for maximum output. Slight variations of the tuning of the secondary of the first i-f transformer and the tuned circuit of the crystal filter may be required to obtain the desired crystal band width. This procedure is described in detail in sub-paragraph (10). The tuning adjustments of the second i-f transformer may also serve as a control of the overall gain of the i-f amplifier and the maximum overall noise output level of the receiver reduced to 15 milliwatts or less by slightly detuning one or both of the second i-f transformer tuned circuits. The fourth i-f transformer is slightly over-coupled with the resultant double response peaks symmetrically located approximately 5 kilocycles each side of the 915-kc, i-f alignment frequency. In general, it will not be necessary

to realign this transformer because of its broad characteristic. However, if realignment becomes necessary, follow this procedure:

Connect the modulated test oscillator through a 0.1-mfd capacitor to the grid of Tube VT-93 (JAN-6B8, third i-f amplifier tube) and to ground. Set the input frequency at 910 kc and alternately adjust first the primary tuning core, then the secondary tuning core of the fourth i-f transformer until maximum output is obtained (both cores turned in a right-hand screw direction). Then turn the modulated test oscillator slowly through the 915-kc setting to approximately 920 kc where a second response peak approximately equal in amplitude to that at 910 kc should be obtained. This indicates correct alignment. Slight supplementary adjustments of the primary and secondary tuning cores may be necessary to secure a symmetrical double peak response with the slight hollow between response peaks located at the 915-kc alignment frequency. If a sweep frequency modulated test oscillator is available, this fourth i-f transformer can

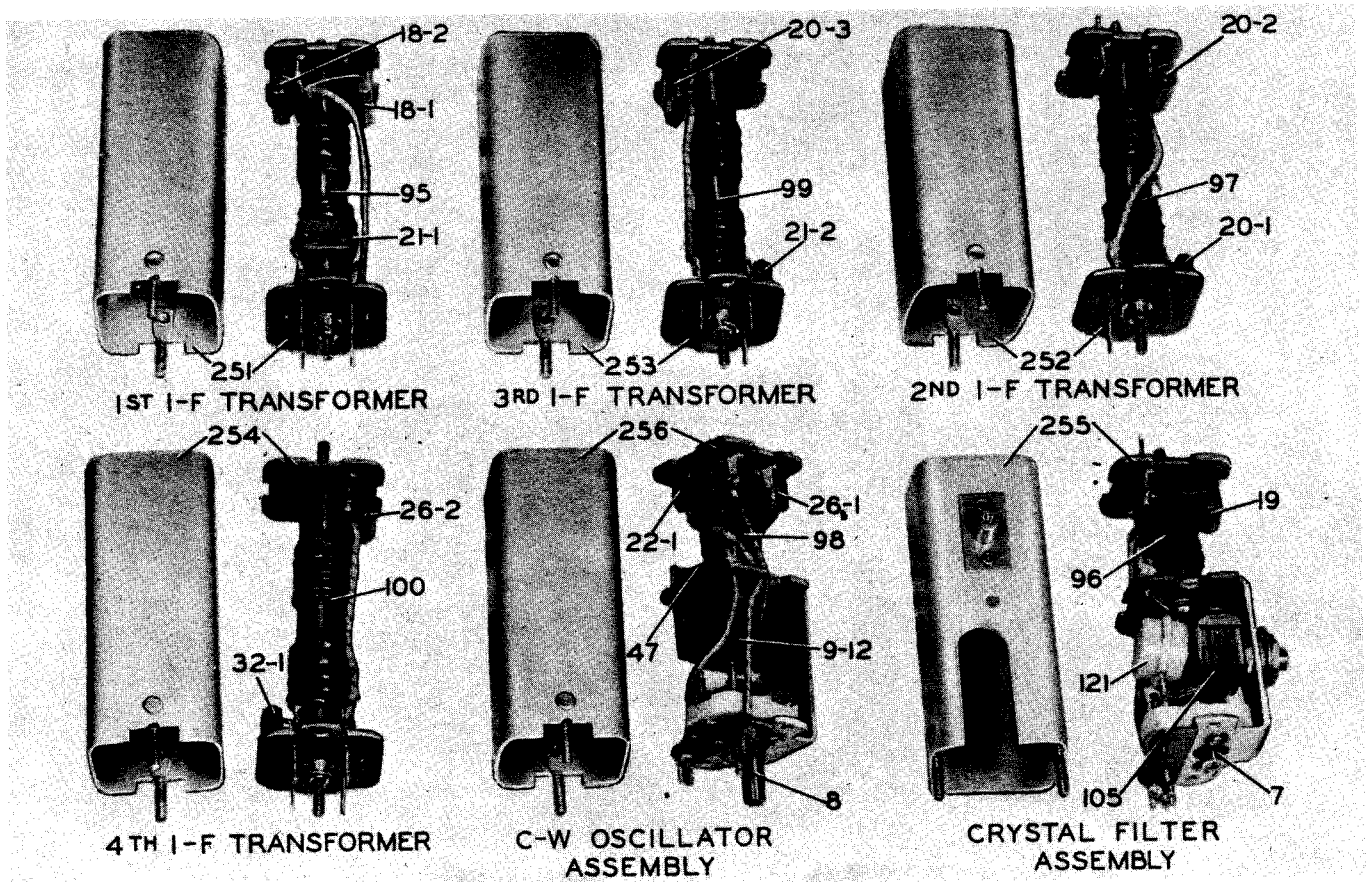

Figure 17 — I-F Transformers, C-W Oscillator and Crystal Filter Assemblies

be conveniently aligned by visual observation on a cathode ray oscilloscope. In this case, the tuning core adjustments are made to obtain a double peak response pattern centered at 915 kc.

(9) CHECK AND ALIGNMENT OF C-W OSCILLATOR.—Check the c-w oscillator and adjust by coupling the 915-kc input (modulation off) to the grid of the first detector tube and then switching the c-w oscillator ON. With the beat frequency control set at mid-position, the oscillator inductance tuning core 98 is adjusted for zero beat. If no c-w beat can be heard, check the c-w oscillator circuit for grounds, shorts, or defective components. With the c-w oscillator ON, the screen voltage at the first and second i-f sockets drops to approximately .45 volts (measured to ground).

(10) TEST AND ADJUSTMENT OF CRYSTAL BAND PASS FILTER.—Normally, the crystal band pass filter is adjusted at the factory for a band width of 1500 to 2000 cycles at 20 db down from resonance. This filter can be tested by applying an unmodulated signal of approximately 915 kc, connected through a 0.1-mfd capacitor to the grid of the first detector tube and ground. With crystal filter switch IN and a 200-microampere meter connected in the lead from volume control 59-B

to the cathode of the third i-f amplifier Tube VT-93 (JAN-6B8, available at the bottom terminal of the rear volume control) vary the frequency of the test oscillator until the response peak of the crystal filter is located. Then adjust the signal input voltage or the volume control (MVC) to give a reading of approximately 70 microamperes on the response peak. Switching the crystal filter OUT should not produce a reading of more than 110 microamperes. This test indicates the correct functioning of this filter. The c-w oscillator should be off during this test. To adjust the band width of the crystal filter, a signal generator or microvolter having an expanded tuning scale in the vicinity of 915 kc and having also an attenuator with a multiplier of 10 times (20db) is required. The following procedure is recommended: Tune the signal input to the crystal filter response peak (crystal IN) and an output reading of 100 microamperes, set the attenuator to multiply the input voltage by 10 times and detune the signal generator on each side of resonance, noting the frequencies of the points where a reading of 100 microamperes is again obtained. From the difference of these frequency readings, the crystal filter band width can be determined. Adjust the band width by changing the capacity setting of balancing ca-

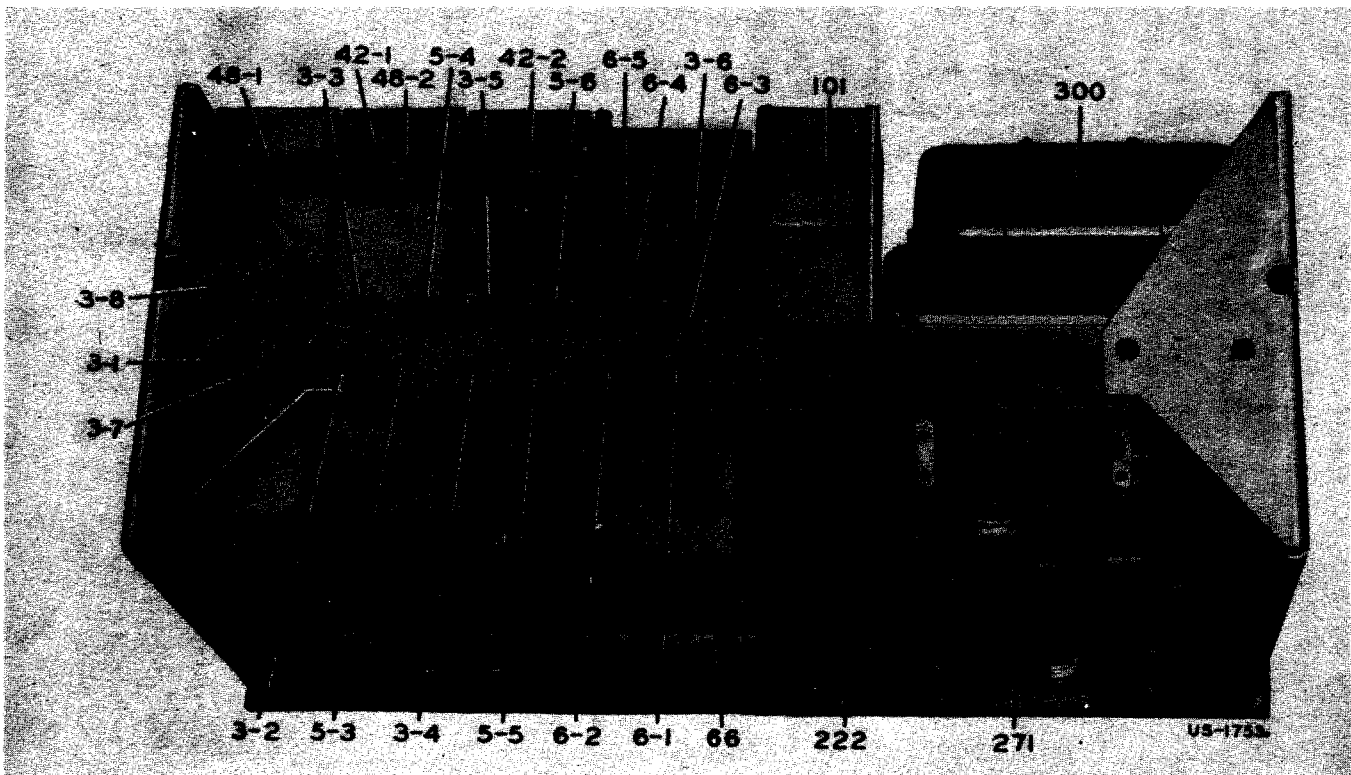

Figure 18 — Radio Receiver BC-348-(*) or BC-224-(*), Rear View of Chassis

capacitor 7. For each setting of this capacitor check the band width at 10 times input as described above. In general the minimum band width is obtained with the balancing capacitor at approximately midcapacity (adjustment slot perpendicular to front panel). The tuning of the secondary of the first i-f transformer and the tuned circuit of the crystal filter influence the band width obtainable with the crystal filter. Slight readjustment of these tuning cores may be necessary to obtain the desired band width. After concluding the above tests, remove the microammeter and restore the circuit to normal.

(11) CHECK OF HETERODYNE OSCILLATOR. Having checked the functioning of the i-f and audio amplifiers, if signals are not heard on any band, check the heterodyne oscillator for oscillation. This can be done by observing the cathode voltages at the socket of the first detector Tube VT-91 (JAN-6J7) when grounding the stator of the oscillator section (1-D) of the tuning capacitor. If no change in voltage is noted with this test, check the oscillator circuit for grounds, short or defective components.

(12) TEST OF THE R-F AMPLIFIER.—Having completed the test and alignment of the audio amplifier, i-f amplifier and heterodyne oscillator, test the r-f amplifier as follows: with the band switch set on the band lacking sensitivity, a modulated signal from the test oscillator is capacitively coupled through a 100-mmf dummy antenna to the antenna post and to ground. Set

this input signal frequency quite accurately to the alignment frequency shown in table II for the band under test. With the tuning control set for the approximate alignment frequency, tune slowly around this point until the maximum response with the least signal input is obtained. Capacitively coupling the test oscillator to the grid of the first r-f and second r-f tubes should show a progressive decrease in output indicating the proper functioning of the particular r-f stage or circuits preceding. If a decrease in response is noted when the signal input is capacitively coupled progressively from the grid of the first detector to the second and first r-f grid caps and finally to the antenna post (with the 100-mmf dummy antenna capacitor) check the stage which indicates a decrease in response for circuit, ground, shorts or defective components.

(13) ALIGNMENT OF R-F AMPLIFIER.

NOTE

For a general alignment start with the 0.2-0.5 MC band No. 1.

In the r-f alignment for any particular band, adjust the tuning control for the alignment frequency (table II) and couple the modulated test signal at this alignment frequency from the test oscillator to the antenna post through the 100-mmf dummy antenna. The three r-f trimmers (ANT., R.F., and DET.) for this band are then adjusted for maximum output. A similar procedure is followed in the alignment of each band.

TABLE II — ALIGNMENT DATA

Band No.	Freq. Range MC	Alignment Frequency MC	Trimmers*			
			Ant.	RF	1 Det.	Osc.
1	0.2- 0.5	0.5	65	37-1	37-2	6-1, 66***
2	1.5- 3.5	3.5	2**	5-3	5-5	6-2
3	3.5- 6.0	6.0	3-1	3-2	3-4	6-3
4	6.0- 9.5	9.5	3-7	5-4	5-6	6-4
5	9.5-13.5	13.5	3-8	3-3	3-5	6-5
6	13.5-18.0	18.0	4-1	4-2	4-3	3-6

* Refer to schematic diagram and marked photographs for location. The alignment controls for the various bands are numbered on the chassis adjacent to the control. Controls for band 1 are marked 1, those for 2 are marked 2, etc.

** Antenna alignment control.

*** Adjust series paddler with receiver set at 200 kc. (Use c-w signal.)

(14) ALIGNMENT OF HETERODYNE OSCILLATOR.

NOTE

For a general alignment start with the 0.2-0.5 MC band No. 1.

The alignment of the heterodyne oscillator is necessary only when the tuning dial frequency calibration is in error by more than 0.75 per cent. To align the oscillator follow the same general procedure as was followed for the alignment of the r-f amplifier. With BAND SWITCH on band No. 1 (0.2-0.5 mc) and TUNING CONTROL set to the alignment frequency, couple the output of the modulated test oscillator (set at the alignment frequency) to the antenna post through the 100-mmf dummy antenna. The oscillator trimmer for this

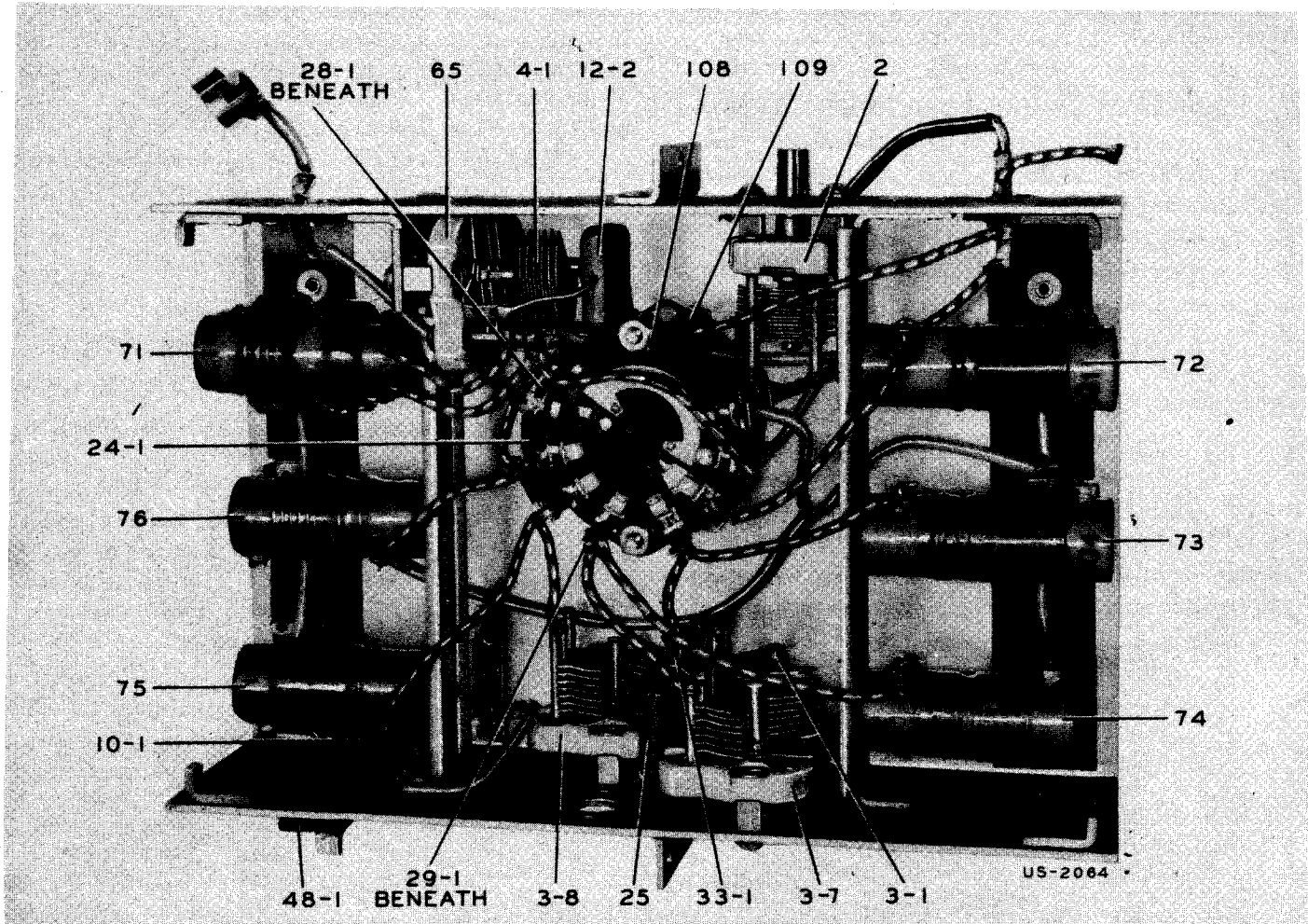

Figure 19 — Antenna Unit

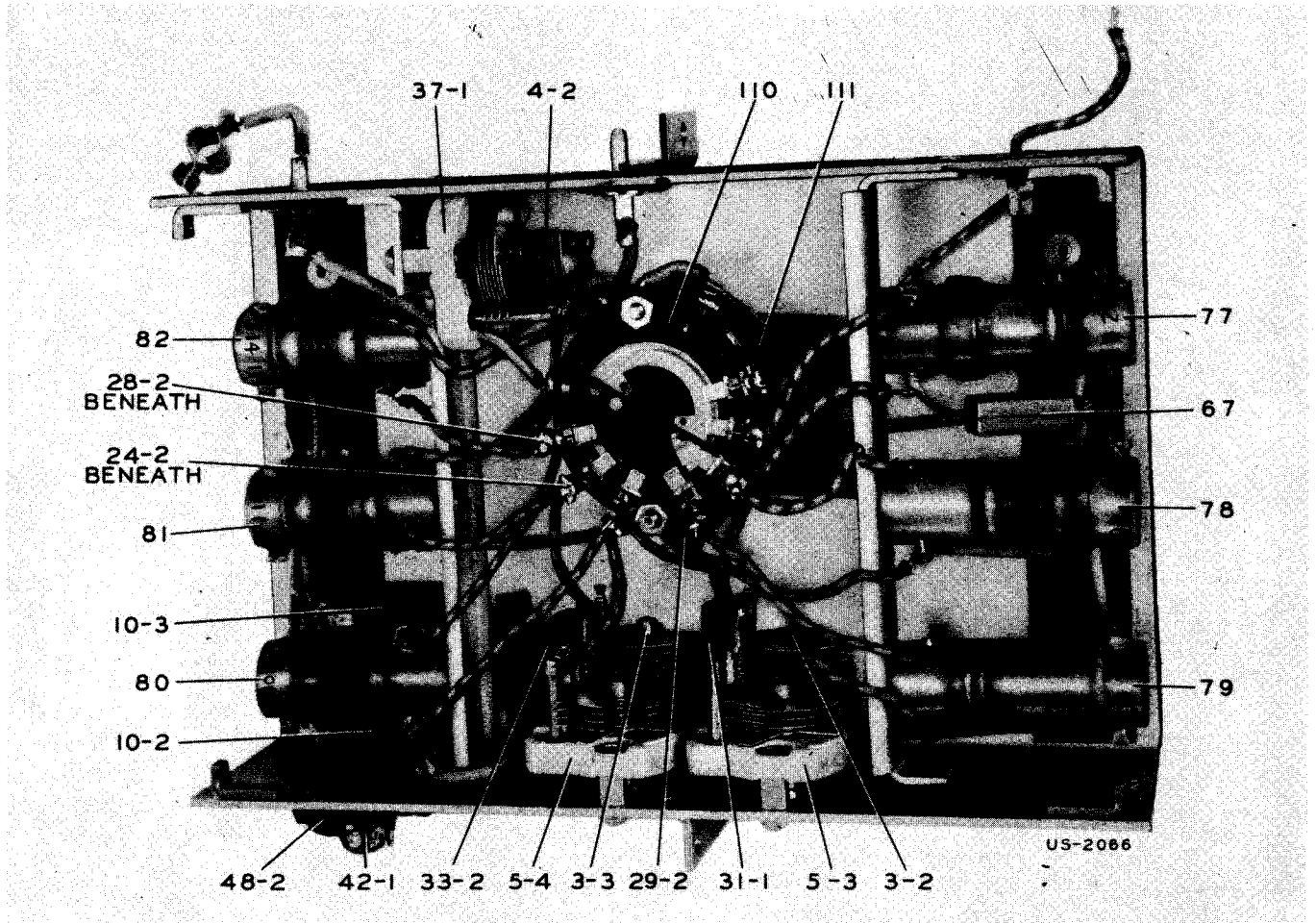

Figure 20 — R-F Unit

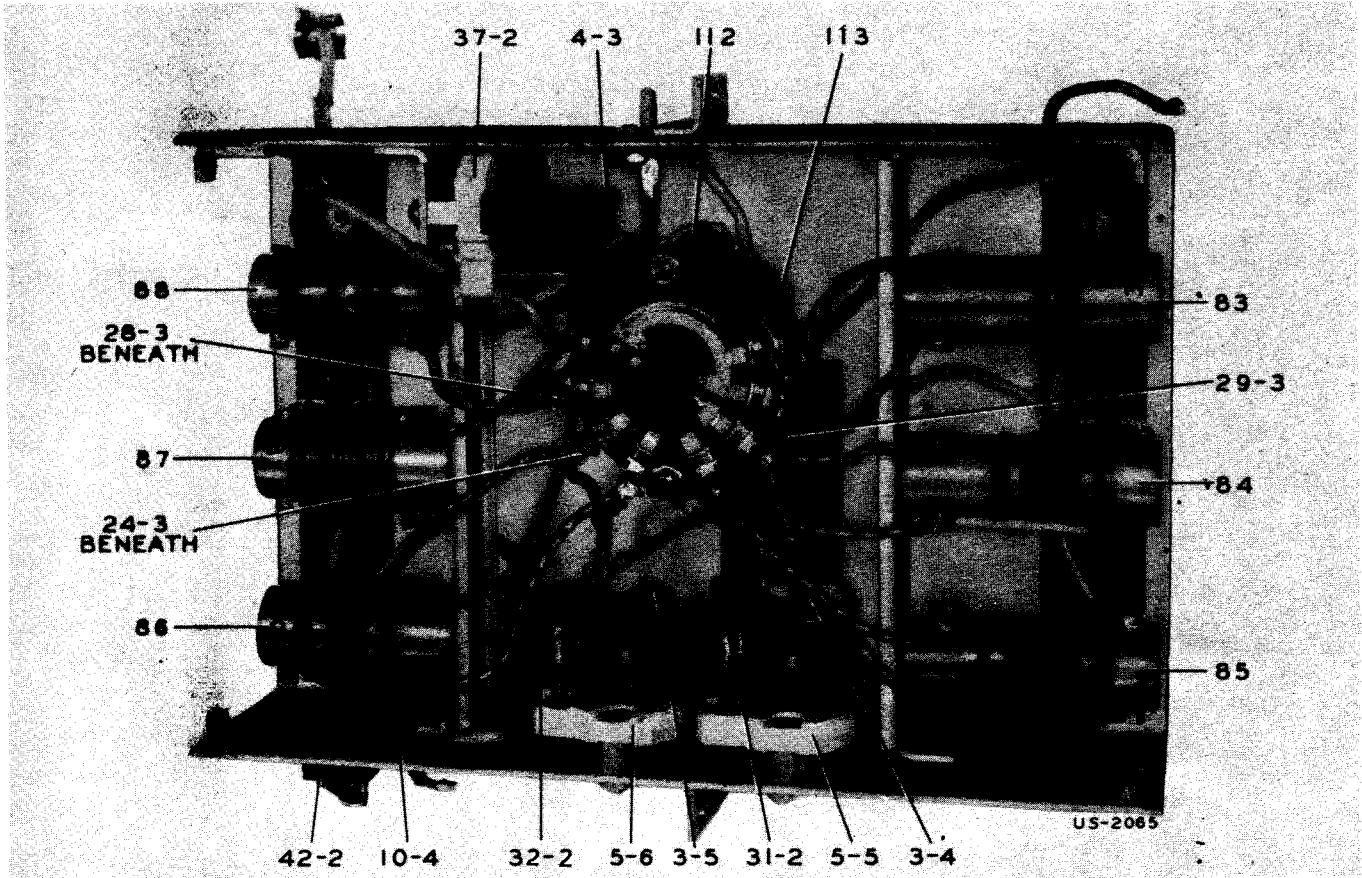

Figure 21 — Detector Unit

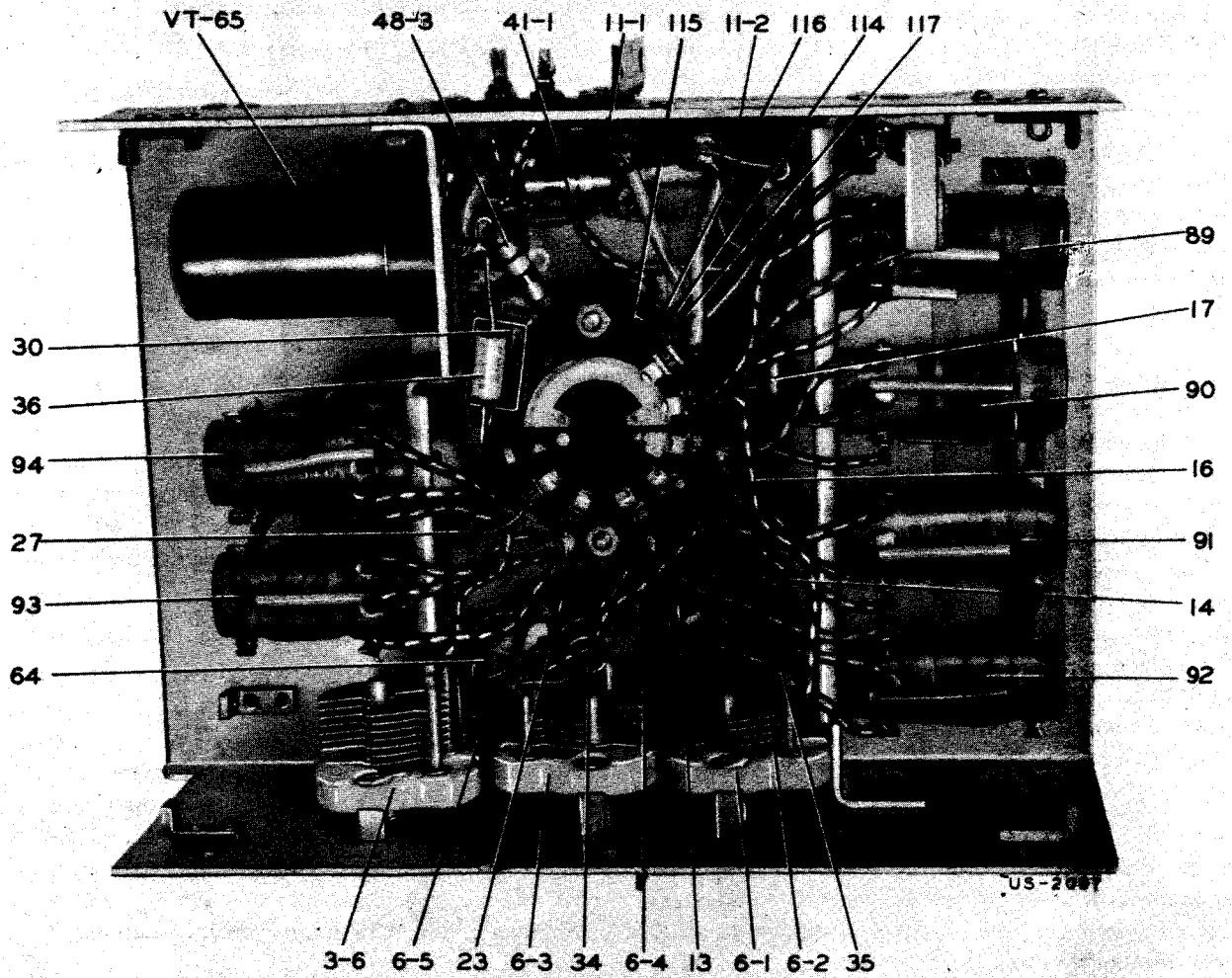

Figure 22 — Oscillator Unit

Section V
Paragraph 8

RESTRICTED
AN 08-10-209

band is adjusted for maximum audio output. A similar procedure is followed in the alignment of each band.

d. WEAK OR NO SIGNALS ON ANY ONE BAND, MODULATED RECEPTION.—The condition of satisfactory reception on several bands and weak or no signals on one or more bands indicates the correct functioning of the i-f and a-f amplifiers and requires checking only the r-f amplifier and heterodyne oscillator for the defective band or bands. Follow the procedure outlined in sub-paragraphs (11) to (14) for the defective band or bands.

e. WEAK OR NO SIGNALS ON ALL BANDS, C-W RECEPTION (MODULATED RECEPTION NORMAL).—Weak or no signals on all bands for c-w reception with satisfactory modulated signal reception requires testing and alignment of the c-w oscillator. Proceed as outlined in sub-paragraphs (8) and (9) above.

f. MEASUREMENTS WITH TEST SET I-56-A.—The following readings are typical values obtained on the Weston model 665-2 selective analyzer (Test Set I-56-A). If all plugs seem to be securely in position with the dynamotor running, and faulty or poor operation is obtained from the receiver, make a careful check first of the cables and plugs using the model 564 volt ohmmeter as outlined under "Detailed Tests on Radio Sets," page 11 of the instruction book for Test Set I-56-A. If all plug-in cable connections seem to be functioning properly, make a test of the tubes in the receiver using the model 685 tube tester as outlined in the same paragraphs as mentioned above. Should neither of these tests locate the difficulty, perform the following voltage and current or resistance measurements.

(1) VOLTAGE AND CURRENT MEASUREMENTS.—Set up the receiver and a model 665 analyzer for operation as outlined under general voltage and current measurements. To obtain the various readings, connect the jumper leads from the socket selector block

to the analyzer pin jacks according to the instructions given below.

(a) Release the thumb screws and pull the complete chassis out of the case.

(b) Make power connections to the plug socket at the rear of the receiver chassis.

(c) Be sure the plug and tube top grid connections are secure when taking readings.

(d) Keep the analyzer AC-DC switch on DC.

(e) Place the analyzer left-hand toggle switch in the VOLTS-MA position.

(f) Connect the short jumper cables for the various tests as indicated in table VII—Tube Voltage Chart.

(g) Connect the jumper cable from black terminal GND to receiver chassis.

(h) Set the receiver control switch on the MVC position unless otherwise specified.

(i) Set the receiver with the volume control at the maximum position (extreme clockwise).

(j) Set the tuning control to 0.2 mc (low-frequency end of band 1). Readings should deviate but slightly when switching to other bands with the tuning control remaining at the low frequency end of each band.

(k) The c-w oscillator should be OFF for the readings in table III and ON for the readings in table IV.

(2) RESISTANCE AND CONTINUITY MEASUREMENTS.—Remove the chassis from the cabinet and do not make any connections to the plug socket at the rear of the chassis. This procedure permits the operation of all switches without running the dynamotor and causing voltages to be built up across the various resistors and capacitors. Any voltages set up by the dynamotor in the receiver would cause serious errors in reading on the ohmmeter ranges or might possibly damage the test instruments.

NOTE

The readings given for tables III, IV, V, and VI are average values taken on receivers of this type using a 28-volt or 14-volt power supply

(depending on the type of receiver). Meter indications within $\pm 10\%$ of these values will in most cases indicate correct operation.

TABLE III — CURRENT AND VOLTAGE MEASUREMENTS WITH "C.W. OSC." OFF

Stage	Tube	Plate Volts	Screen Volts	Cathode Volts	Heater Volts	Ma Plate Current	Ma Screen Current
1 R-F	JAN-6K7 (VT-86)	184	70	2.6	6.3	4.1	1.0
2 R-F	JAN-6K7 (VT-86)	177	86	3.2	6.3	4.8	1.3
1 det	JAN-6J7 (VT-91)	202	96	4.2	6.3	0.23	0.08

TABLE III — CURRENT AND VOLTAGE MEASUREMENTS WITH "C.W. OSC." OFF (Continued)

Stage	Tube	Plate Volts	Screen Volts	Cathode Volts	Heater Volts	Ma Plate Current	Ma Screen Current
Osc	JAN-6C5 (VT-65)	58		0.0	6.3	1.6	
1 I-F	JAN-6K7 (VT-86)	182	82	3.1	6.5	4.7	1.2
2 I-F	JAN-6F7 (VT-70)	207	82	3.1	6.5	4.5	1.4
3 I-F	JAN-6B8 (VT-93)	207	72	21.0	6.5	2.5	0.6
Output	JAN-41 (VT-48)	197	207	0.0	6.5	18.0	3.2
2 det	JAN-6B8 (VT-93) diode	8.0					

TABLE IV — CURRENT AND VOLTAGE MEASUREMENTS WITH "C.W. OSC." ON

Stage	Tube	Plate Volts	Screen Volts	Cathode Volts	Heater Volts	Ma Plate Current	Ma Screen Current
1 R-F	JAN-6K7 (VT-86)	197	37	1.3	6.3	2.0	0.55
2 R-F	JAN-6K7 (VT-86)	188	65	2.3	6.3	3.7	1.0
1 det	JAN-6J7 (VT-91)	204	72	3.4	6.3	0.17	0.06
Osc	JAN-6C5 (VT-65)	58		0.0	6.3	1.6	
1 I-F	JAN-6K7 (VT-86)	195	44	1.6	6.5	2.3	0.5
2 I-F	JAN-6F7 (VT-70)	210	44	1.6	6.5	2.2	0.5
3 I-F	JAN-6B8 (VT-93)	210	72	21.0	6.5	2.2	0.6
Output	JAN-41 (VT-48)	198	210	0.0	6.5	23.5	3.6
C-W osc	JAN-6F7 (VT-70) triode	18.0					

TABLE V — RESISTANCE TO GROUND (OHMS) WITH "C.W. OSC." OFF

Stage	Tube	Cathode	Plate	Screen	"MVC" Grid	"AVC" Grid
1 R-F	JAN-6K7 (VT-86)	490	5200	80,000	100,000	1.8 meg
2 R-F	JAN-6K7 (VT-86)	480	5200	75,000	100,000	1.8 meg
1 det	JAN-6J7 (VT-91)	15,000	5600	75,000	0	0
Osc	JAN-6C5 (VT-65)	0	41,000		100,000	100,000
1 I-F	JAN-6K7 (VT-86)	520	5600	70,000	500,000	1.8 meg
2 I-F	JAN-6F7 (VT-70)	470	500	70,000	500,000	2.25 meg

TABLE V — RESISTANCE TO GROUND (OHMS) WITH "C.W. OSC." OFF (Continued)

Stage	Tube	Cathode	Plate	Screen	"MVC" Grid	"AVC" Grid
3 I-F	JAN-6B8 (VT-93)	6200	500	180,000	5000	5000
Output	JAN-41 (VT-48)	0	1080	480	700,000	

TABLE VI — RESISTANCE TO GROUND (OHMS) WITH "C.W. OSC." ON

Stage	Tube	Cathode	Plate	Screen	"MVC" Grid	"AVC" Grid
1 R-F	JAN-6K7 (VT-86)	490	5200	20,000	100,000	1.8 meg
2 R-F	JAN-6K7 (VT-86)	480	5200	23,000	100,000	1.8 meg
1 det	JAN-6J7 (VT-91)	15,000	5600	23,000	0	0
Osc	JAN-6C5 (VT-65)	0	41,000		100,000	100,000
1 I-F	JAN-6K7 (VT-86)	520	5600	9200	500,000	1.8 meg
2 I-F	JAN-6F7 (VT-70)	470	500	9200	500,000	2.25 meg
3 I-F	JAN-6B8 (VT-93)	6200	500	180,000	5000	5000
Output	JAN-41 (VT-48)	0	1080	480	700,000	
C-W osc	JAN-6F7 (VT-70)		82,000		500,000	
Det diode	JAN-6B8 (VT-93)		180,000			
AVC diode	JAN-6B8 (VT-93)		380,000			

(a) Set the receiver control switch to MVC unless otherwise specified.

(b) Set the receiver with the volume control at the maximum position (extreme clockwise).

(c) Set the tuning control to 0.2 mc (low-frequency end of band 1). Readings should not deviate when switching to other bands with the tuning control remaining at the low-frequency end of each band.

(d) The c-w oscillator should be OFF for the readings in table V and ON for the readings in table VI.

(e) Shift the analyzer left-hand toggle switch to the ohms position. Set up the model 665 analyzer for resistance and continuity measurements as outlined under "General Resistance and Continuity Tests" in the test set instruction book. Before taking a resistance reading on any range, short the two jumper leads plugged into the ohmmeter pin jacks and rotate the battery adjustment knob until the instrument pointer reads ex-

actly full scale. Should it be found impossible to bring the pointer up to the top mark, refer to the paragraphs on battery replacement under the heading "Maintenance" in the test set instruction book. Plug the pin tip end of the 3-foot clip lead into the block hole marked GND and clip the other end to the chassis. Connect one of the jumper leads between the remaining ground jack and one of the ohmmeter jacks on the required range. Connect the other jumper lead from the remaining ohmmeter range jack to the tube element under test. In general, ohmmeter readings will be most accurate when taken on the upper $\frac{2}{3}$ of the scale. Wherever possible, choose the range that will give indications in this area.

g. FAILURE OF DIAL LIGHTS. — The two dial lamps are connected in series, hence, the failure of either lamp does not indicate failure of both lamps. Removal of the dial light housing gives ready access to the lamps. For replacement procedure see paragraph 2a of this section.

SECTION VI
SUPPLEMENTARY DATA

TABLE VII — TUBE VOLTAGE AND CURRENT CHART

Tests made with Model 665 Analyzer and Model 666 Socket Selector Block, part of Test Set I-56-A, with input voltage of 28 volts for BC-348-(*) and 14 volts for BC-224-(*). All values are subject to $\pm 10\%$ variation.

All readings taken with C.W. oscillator OFF.

Test	Tube	Function	Analyzer Jacks	Block Terminals	Meter Reading
Plate Voltage	JAN-6K7 (VT-86)	1st R-F	250v and \pm	3 and GND	184
	JAN-6K7 (VT-86)	2nd R-F	250v and \pm	3 and GND	177
	JAN-6K7 (VT-86)	1st I-F	250v and \pm	3 and GND	182
	JAN-6F7 (VT-70)	2nd I-F and C.W. OSC.	250v and \pm	2 and GND	205
	JAN-6J7 (VT-91)	1st Det	250v and \pm	3 and GND	202
	JAN-6B8 (VT-93)	2nd Det and 3rd I-F	250v and \pm	3 and GND	207
	JAN-41 (VT-48)	Output	250v and \pm	2 and GND	197
Screen Voltage	JAN-6K7 (VT-86)	1st R-F	250v and \pm	4 and GND	70
	JAN-6K7 (VT-86)	2nd R-F	250v and \pm	4 and GND	86
	JAN-6K7 (VT-86)	1st I-F	250v and \pm	4 and GND	82
	JAN-6F7 (VT-70)	2nd I-F and C.W. OSC.	250v and \pm	3 and GND	82
	JAN-6J7 (VT-91)	1st Det	250v and \pm	4 and GND	96
	JAN-6B8 (VT-93)	2nd Det and 3rd I-F	250v and \pm	6 and GND	72
	JAN-41 (VT-48)	Output	250v and \pm	3 and GND	207
Cathode Voltage	JAN-6K7 (VT-86)	1st R-F	10v and \pm	8 and GND	2.6
	JAN-6K7 (VT-86)	2nd R-F	10v and \pm	8 and GND	3.2
	JAN-6K7 (VT-86)	1st I-F	10v and \pm	8 and GND	3.1
	JAN-6F7 (VT-70)	2nd I-F and C.W. OSC.	10v and \pm	6 and GND	3.1
	JAN-6J7 (VT-91)	1st Det	10v and \pm	8 and GND	4.2
	JAN-6B8 (VT-93)	2nd Det and 3rd I-F	25v and \pm	8 and GND	21
	JAN-41 (VT-48)	Output	25v and \pm	5 and GND	0
Heater Voltage	JAN-6K7 (VT-86)	1st R-F	10v and \pm	2 and 7	6.5
	JAN-6K7 (VT-86)	2nd R-F	10v and \pm	2 and 7	6.5
	JAN-6K7 (VT-86)	1st I-F	10v and \pm	2 and 7	6.5
	JAN-6F7 (VT-70)	2nd I-F and C.W. OSC.	10v and \pm	1 and 7	6.5
	JAN-6J7 (VT-91)	1st Det	10v and \pm	2 and 7	6.5
	JAN-6B8 (VT-93)	2nd Det and 3rd I-F	10v and \pm	2 and 7	6.5
	JAN-41 (VT-48)	Output	10v and \pm	6 and 1	6.5
Diode Voltage	JAN-6B8 (VT-93)	2nd Det	100v and \pm	5 and GND	8
Plate Current	JAN-6K7 (VT-86)	1st R-F	10 MA and —	3-3	4.1
	JAN-6K7 (VT-86)	2nd R-F	10 MA and —	3-3	4.8
	JAN-6K7 (VT-86)	1st I-F	10 MA and —	3-3	4.7
	JAN-6F7 (VT-70)	2nd I-F and C.W. OSC.	5 MA and —	2-2	4.5
	JAN-6J7 (VT-91)	1st Det	10 MA and —	3-3	0.23
	JAN-6B8 (VT-93)	2nd Det and 3rd I-F	10 MA and —	3-3	2.5
	JAN-41 (VT-48)	Output	25 MA and —	2-2	18.0

TABLE VII — TUBE VOLTAGE AND CURRENT CHART (Continued)

Test	Tube	Function	Analyzer Jacks	Block Terminals	Meter Reading
Screen Current	JAN-6K7 (VT-86)	1st R-F	5 MA and —	4-4	1.0
	JAN-6K7 (VT-86)	2nd R-F	5 MA and —	4-4	1.3
	JAN-6K7 (VT-86)	1st I-F	5 MA and —	4-4	1.2
	JAN-6F7 (VT-70)	2nd I-F and C.W. OSC.	5 MA and —	3-3	1.4
	JAN-6J7 (VT-91)	1st Det	5 MA and —	4-4	0.08
	JAN-6B8 (VT-93)	2nd Det and 3rd I-F	1 MA and —	6.6	0.6
	JAN-41 (VT-48)	Output	5 MA and —	3-3	3.2

NOTE: Voltage at the socket of R-F oscillator tube JAN-6C5 (VT-65) cannot be checked because of its location.

TABLE VIII — CHARACTERISTICS OF TUBES, LAMPS, VOLTAGE REGULATOR AND FUSES

TUBE CHARACTERISTICS

(Table applies to either 14-volt receiver or 28-volt receiver)

Tube	Heater		Screen Volts	Plate Volts	Grid Volts	Plate Ma	Screen Ma	μ	Plate Resistance Ohms	Transconductance Micromhos
	Volts	Amps.								
JAN-6K7 (VT-86)	6.3	0.3	100	250	-3	7.0	1.7	1,160	800,000	1,450
JAN-6J7 (VT-91)	6.3	0.3	100	250	-3	2.0	0.5	1,500	1,500,000	1,225
JAN-6F7 (VT-70)	6.3	0.3	100	250	-3	6.5	1.5	900	850,000	1,100
		Tri.	—	100	-3	3.5	—	8	16,000	500
JAN-6B8 (VT-93)	6.3	0.3	125	250	-3	10	2.3	800	600,000	1,325
JAN-6C5 (VT-65)	6.3	0.3	—	250	-8	8	—	20	10,000	2,000
JAN-41 (VT-48)	6.3	0.4	250	250	-18	32	5.5	150	68,000	2,200

DIAL LAMPS

Type	Volts	Amps.
LM-27	6.3	0.25

VOLTAGE REGULATOR RCA-991

Starting supply voltage	87 volts min.
Operating voltage	60 volts
Operating current	0.5 to 2 milliamperes

FUSES

Type	Receiver	Amps.
FU-35	BC-348-(★)	5
FU-23	BC-224-(★)	10

TABLE IX — DESCRIPTION OF TRANSFORMERS (Ref. Nos. 71-100)

Reference No.	Description	Function
71-76	Antenna bands 1-6	1st R-F tuned circuit
77-80	R-F bands 1-4	1st R-F to 2nd R-F coupling
81-82	R-F bands 5-6	1st R-F to 2nd R-F coupling
83-88	1st detector band 1-6	2nd R-F to 1st detector coupling
89-93	Oscillator band 1-5	Oscillator to 1st detector coupling
94	Oscillator band 6	Oscillator to 1st detector coupling
95	1st I-F	1st detector to crystal coupling
96	Crystal filter	Crystal to 1st I-F coupling
97	2nd I-F	1st I-F to 2nd I-F coupling
98	C-W oscillator	Grid and plate coupling
99	3rd I-F	2nd I-F to 3rd I-F coupling
100	4th I-F	3rd I-F to 2nd detector coupling

TABLE X — PARTS DESCRIBED BUT NOT STOCKED

<i>Reference No.</i>	<i>Name of Part</i>	<i>Description</i>	<i>Function</i>
315	End bell	Part of dynamotor, type 3-1030A or equivalent	Low voltage end bearing
316	End bell	Part of dynamotor, type 3-1031A or equivalent	High voltage end bearing
319	Tie bars	Part of dynamotor, type SCR-187 or equivalent	Hold items 315, 316 to frame
320	Brush caps	Part of dynamotor, type 4-1007A or equivalent	Holds brushes
321	Grommet	Part of dynamotor, type GRO-106 or equivalent	Protects terminal wires
322	Gasket	Part of dynamotor, type GAS-101 or equivalent	Prevents leakage of lubricant
323	Plate	Part of dynamotor, type EPL-101 or equivalent	Bearing retainer
324	Cover	Part of dynamotor, type COV-125 or equivalent	Dust cover
350	Bracket and gear assembly	Pair of bevelled gears and coupling	Drives band change switch
351	Coupling	Flanged collar with rectangular slot	Coupling band change knob shaft to 350
352	Coupling slide	Disc with two rectangular keys	Slide between 2 of 351
353	Window frame assembly	Removable cast housing which holds dial glass	Covers dial lamps
355	Friction spreader	Phosphor bronze spring	Prevents controls from turning under vibration
356	Jack cover assembly	Spring actuated cover	Seals jack openings
357	Bushing	Threaded bushing	Holds handle to panel and provides bearing for thumb screw
358	Nut	Special locking nut	Holds 357
359	Thumb screw assembly	No. 10-24 x $\frac{1}{32}$ " long (less knob)	Holds chassis in cabinet
360	Nut	Special locking nut	Holds upper end of handles
361	Flexible shaft and coupling	5 $\frac{1}{2}$ " long including couplings, special	Operates c-w oscillator
362	Extension shaft	Special shaft, 0.594" long	Operates crystal ON-OFF switch
363	Shaft and coupling assembly	Flexible shaft with insulated coupling	Operates antenna trimmer
364	Switch shaft	Flat shaft, type A-141645-1	Operates band switch
366	Dial mask assembly	Plate with cutouts	Masks undesired dial scales
367	Dial assembly	Calibrated circular dial with hub and large spur gear	Gives frequency setting
368	Stop arm assembly	Lever with roller and pawl	Stops condenser at end of travel
369	Index plate	Phosphor bronze strip painted red	Dial scale index
370	Stop	Cast bushing with key	Stops stop arm
371	Stud	Shouldered stud threaded 4-40 one end	Pivot pin for part 368
378	Guide assembly	Arm and roller assembly	Engages index wheel for switch locations

TABLE X — PARTS DESCRIBED BUT NOT STOCKED (Continued)

<i>Reference No.</i>	<i>Name of Part</i>	<i>Description</i>	<i>Function</i>
373	Spring	Coiled spring	Operation of indexing arm 372
374	Gear and pinion assembly	Spur gear and pinion assembly	Idler reducing gear between tuning shaft and dial
375	Pinion	Pinion (pinned to tuning shaft)	Dial drive pinion meshing with 374
376	Worm	Worm, single pitch	Drives cross shaft of condenser drive
377	Gear assembly	Split worm wheel	Part of condenser drive train
378	Pinion and bushing assembly	Pinion on cross shaft	Drives tuning condenser gear
379	Spring	Torsion spring	Holds 368
380	C washer	C washer	Against dial used to retain items 372 and 374
399	Mounting	Mounting base assembly	Supports receiver
400	Mounting plate assembly	Part of 399	Supports 401
401	Base and stiffener assembly	Part of 399	Supports receiver and plug 403 or 404
402	Cap screw	1/4-20 x 1 1/16 long	
403	PL-P103	8-pole female power connector	Makes connection to exterior equipment
404	PL-Q103	8-pole female power connector	Makes connection to exterior equipment
405	Jack block	Part of 403 and 404	Holds contactors
406	Jack block	Part of 403 and 404	Holds contactors
407	Jack block	Part of 403 and 404	Holds contactors
408	Jack block	Part of 403 and 404	Holds contactors
409	Jack housing assembly	Part of 403 and 404	Houses jack blocks
410	Fitting (right angle)	Part of 404	Cable protection and shielding
411	Fitting (straight)	Part of 403	Cable protection and shielding
412	Contact spring assembly	Part of 403 and 404	Contact
413	Jack housing cover	Part of 403 and 404	Covers jack block terminals
414	Cover	Part of 257	Top
415	Cover	Part of 257	Bottom
416	Shield	Part of 257	Side and ends
417	Cover	Part of 258	Top
418	Cover	Part of 258	Bottom
419	Shield	Part of 258	Side and ends
420	Cover	Part of 259	Top

TABLE X — PARTS DESCRIBED BUT NOT STOCKED (Continued)

Reference No.	Name of Part	Description	Function
421	Cover	Part of 259	Bottom
422	Shield	Part of 259	Side and ends
423	Cover	Part of 260	Top
424	Cover	Part of 260	Bottom
425	Cover	Part of 260	Side
426	Shield	Part of 260	Side and ends
427	Shield can	Part of 251	Top
428	Shield can	Part of 252	Top
429	Shield can	Part of 253	Top
430	Shield can	Part of 254	Top
431	Shield can	Part of 255	Top
432	Shield can	Part of 256	Top
433	Tube guide	Cylindrical socket for tube base	Supports Tube VT-70 and tube shield
434	Tube guide	Cylindrical socket for tube base	Supports Tube VT-48
435	Shield can, less top	Part of 251	1st I-F Transformer assembly shield
436	Shield can, less top	Part of 252	2nd I-F transformer assembly shield
437	Shield can, less top	Part of 253	3rd I-F transformer assembly shield
438	Shield can, less top	Part of 254	4th I-F transformer assembly shield
439	Shield can, less top	Part of 255	Crystal filter assembly shield
440	Shield can, less top	Part of 256	C-W oscillator assembly
500	Resistor	Variable 200 ohms $\pm 10\%$, special 4 watts	Dial lamp control
501A	Resistor	Insulated 1.7 ohms $\pm 10\%$, type MN-2, 1.5 watts	Filament
501B	Resistor	180 ohms, $\pm 10\%$, type MN-2, 1.9 watts	Filament
503	Resistor	Insulated 60 ohms $\pm 10\%$, 3.7 watts, type MW-2	Dial lamp series
504	Fuse clip assembly	Laminated phenolic strip with fuse clips	Power fuse
511	Armature	Part of 510, type 5-1046A or equivalent	Dynamotor
514 } 515 }	Field windings	Field windings are available in pairs only	Dynamotor

TABLE XI — RMA COLOR CODES

RMA COLOR CODE FOR RESISTORS (OHMS)			
COLOR	A 1st DIGIT	B 2nd DIGIT	C MULTIPLIER
SILVER			0.01
GOLD			0.1
BLACK		0	1.0
BROWN	1	1	10
RED	2	2	100
ORANGE	3	3	1,000
YELLOW	4	4	10,000
GREEN	5	5	100,000
BLUE	6	6	1,000,000
PURPLE	7	7	10,000,000
GRAY	8	8	100,000,000
WHITE	9	9	1,000,000,000

D — TOLERANCE CODE:
 GOLD = 5% SILVER = 10% NO COLOR = 20%

OLD COLOR ARRANGEMENT

NEW COLOR ARRANGEMENT

BODY COLOR (NEW COLOR ARRANGEMENT ONLY) INDICATES TYPE OF RESISTOR, AS FOLLOWS:—
 BLACK — COMPOSITION, NON-INSULATED
 TAN, OLIVE OR WHITE — COMPOSITION, INSULATED
 DARK BROWN — WIRE-WOUND, INSULATED

RMA COLOR CODES FOR CAPACITORS (MMFD)			
COLOR	NUMERAL	VOLTS	MULTIPLIER TOLERANCE
BLACK	0		1
BROWN	1	100	10
RED	2	200	100
ORANGE	3	300	1,000
YELLOW	4	400	10,000
GREEN	5	500	100,000
BLUE	6	600	1,000,000
VIOLET	7	700	10,000,000
GRAY	8	800	100,000,000
WHITE	9	900	1,000,000,000
GOLD		1000	0.1
SILVER		2000	0.01
NO COLOR		500	5% 10% 20%

SECTION VII
TABLE OF REPLACEABLE PARTS — PART I

MODEL: RADIO RECEIVER BC-348-(*) OR BC-224-(*)

Reference Symbol	Army Stock Number Navy Type Number British Reference Number	Name of Part and Description	Function	Mfr. and Designation	Drawing or Specification No.
1-A	3D9016V-2	CAPACITOR: variable; 4-section; 14 to 331 mmfd each section; 9 stator and 10 rotor plates, each section.	Main tuning	Stromberg-Carlson	D-5024
1-B		CAPACITOR: Same as 1-A	Main tuning		
1-C		CAPACITOR: Same as 1-A	Main tuning		
1-D		CAPACITOR: Same as 1-A	Main tuning		
2	3D9050V-60	CAPACITOR: variable; 5 to 50 mmfd; 14 plates; shaft 7/8" long.	Antenna coupling	Stromberg-Carlson	D-3450
3-1	3D9050V-31	CAPACITOR: variable; 5 to 50 mmfd; 14 plates, Oak type #595-C-AI	Antenna unit trimmer	Stromberg-Carlson	D-3458
3-2		CAPACITOR: Same as 3-1	R-F unit trimmer		
3-4		CAPACITOR: Same as 3-1	R-F unit trimmer		
3-5		CAPACITOR: Same as 3-1	1st detector unit trimmer		
3-6		CAPACITOR: Same as 3-1	1st detector unit trimmer		
3-7		CAPACITOR: Same as 3-1	Oscillator unit trimmer		
3-8		CAPACITOR: Same as 3-1 (not used in Radio Receivers BC-348-E, BC-348-M, BC-348-P)	Antenna unit trimmer		
4-1	3D9050V-32	CAPACITOR: variable; 4.5 to 50 mmfd; 14 plates; Oak type A592-C-AI	Antenna unit trimmer	Stromberg-Carlson	D-3448
4-2		CAPACITOR: Same as 4-1	R-F unit trimmer		
4-3		CAPACITOR: Same as 4-1	1st detector unit trimmer		
5-1	3D9025V-4 (also shipped as 3DF100)	CAPACITOR: variable; 4 to 25 mmfd; 7 plates; dimensions 1 7/32" x 1 1/16" x 9/16"; ceramic insulation; parallel trimmers; mounting centers 2 1/32"	Antenna unit trimmer	Oak Mfg. Co. 594-B-AI Radio Condenser type 34 Special Automatic Winding Co. type A754-148	Stromberg-Carlson D-3455
5-2		CAPACITOR: Same as 5-1	Antenna unit trimmer		
5-3		CAPACITOR: Same as 5-1	R-F unit trimmer		

TABLE OF REPLACEABLE PARTS — PART I

MODEL: RADIO RECEIVER BC-348-(*) OR BC-224-(*)

Reference Symbol	Army Stock Number Navy Type Number British Reference Number	Name of Part and Description	Function	Mfr. and Designation	Drawing or Specification No.
5-4		CAPACITOR: Same as 5-1	R-F unit trimmer		
5-5		CAPACITOR: Same as 5-1	1st detector unit trimmer		
5-6		CAPACITOR: Same as 5-1	1st detector unit trimmer		
5-7		CAPACITOR: Same as 5-1	Oscillator unit trimmer		
5-8		CAPACITOR: Same as 5-1	Oscillator unit trimmer		
6-1	3D9025V-5 (also shipped as 3DF105)	CAPACITOR: variable; 4 to 25 mmfd, 7 plates, dimensions $1\frac{1}{32}$ " x $1\frac{1}{16}$ " x $1\frac{1}{32}$ "	Oscillator unit trimmer	Stromberg-Carlson	D-3535
6-2		CAPACITOR: Same as 6-1	Oscillator unit trimmer		
6-3		CAPACITOR: Same as 6-1 (not used in BC-348-E, M, P)	Oscillator unit trimmer		
6-4		CAPACITOR: Same as 6-1 (not used in BC-348-E, M, P)	Oscillator unit trimmer		
6-5		CAPACITOR: Same as 6-1 (not used in BC-348-E, M, P)	Oscillator unit trimmer		
7	3D9010V-3 (also shipped as 3DF103)	CAPACITOR: variable; 3 to 10 mmfd, 3 plates, has parallel trimmer	Crystal filter adjustment	Stromberg-Carlson	D-3823
8	3D9010V-4 (also shipped as 3D102)	CAPACITOR: variable; 3 to 10 mmfd, 3 plates, dimensions $1\frac{1}{32}$ " x $1\frac{1}{16}$ " x $1\frac{1}{16}$ "	C-W oscillator frequency adjustment	Stromberg-Carlson	D-3809
9-1	3DA10-94 (also shipped as 3DA10-96)	CAPACITOR: fixed; 10,000 mmfd, $\pm 10\%$, 500 volts d-c working; paper	1st R-F cathode bypass	RCA	M-420394-1
9-2		CAPACITOR: Same as 9-1	1st R-F screen bypass		
9-3		CAPACITOR: Same as 9-1	2nd R-F cathode bypass		
9-4		CAPACITOR: Same as 9-1	2nd R-F screen bypass		
9-5		CAPACITOR: Same as 9-1	1st detector screen bypass		
9-6		CAPACITOR: Same as 9-1	1st I-F transformer bypass		
9-7		CAPACITOR: Same as 9-1	Crystal filter transformer bypass		
9-8		CAPACITOR: Same as 9-1	1st I-F cathode bypass		

TABLE OF REPLACEABLE PARTS — PART I

MODEL: RADIO RECEIVER BC-348-(*) OR BC-224-(*)

Reference Symbol	Army Stock Number Navy Type Number British Reference Number	Name of Part and Description	Function	Mfr. and Designation	Drawing or Specification No.
9-9		CAPACITOR: Same as 9-1	1st I-F plate bypass		
9-10		CAPACITOR: Same as 9-1	2nd I-F transformer bypass		
9-11		CAPACITOR: Same as 9-1	2nd I-F cathode bypass		
9-12		CAPACITOR: Same as 9-1	C-W oscillator plate bypass		
9-13		CAPACITOR: Same as 9-1	Plug terminal bypass		
9-14		CAPACITOR: Same as 9-1	AVC bypass		
9-15		CAPACITOR: Same as 9-1	3rd I-F transformer bypass		
9-16		CAPACITOR: Same as 9-1	3rd I-F cathode bypass		
9-17		CAPACITOR: Same as 9-1	Heater bypass		
9-18		CAPACITOR: Same as 9-1	Battery bypass		
10-1	3DA10-136 (also shipped as 2C4224A/C9 and 3DA10-136.1)	CAPACITOR: fixed; 10,000 mmfd, $\pm 10\%$, 300 volts d-c working; mica	Antenna coil bypass	RCA	M-420394-23
10-2		CAPACITOR: Same as 10-1	R-F plate bypass		
10-3		CAPACITOR: Same as 10-1	R-F coil bypass		
10-4		CAPACITOR: Same as 10-1	2nd R-F plate bypass		
11-1*		CAPACITOR: Same as 10-1	Heterodyne oscillator plate bypass		
11-2*		CAPACITOR: Same as 10-1	1st detector cathode bypass		
12-1*	3DA5-32	CAPACITOR: fixed; 5,000 mmfd, $\pm 10\%$; 500 volts d-c working; silver mica	Audio transformer secondary bypass	RCA	M-420394-24
12-2*		CAPACITOR: Same as 12-1	Band 1, antenna series		

* See Part II of this table.

TABLE OF REPLACEABLE PARTS — PART I

MODEL: RADIO RECEIVER BC-348-(*) OR BC-224-(*)

Reference Symbol	Army Stock Number Navy Type Number British Reference Number	Name of Part and Description	Function	Mfr. and Designation	Drawing or Specification No.
13*	3D9390	CAPACITOR: fixed; 390 mmfd, $\pm 1.2\%$; 500 volts d-c working; silver mica	Oscillator series	RCA	P-721286-6
14*	3DA2.240-1	CAPACITOR: fixed; 2,240 mmfd, $\pm 3\%$; 500 volts d-c working; salt water seal; silver mica	Oscillator series	RCA	P-721286-9
15-1	3DA1.500-1 (also shipped as 3DA1.500-3)	CAPACITOR: fixed; 1,500 mmfd, $\pm 10\%$; 500 volts d-c working; mica	Audio coupling condenser		
15-2		CAPACITOR: Same as 15-1	Audio transformer primary bypass		
16	3D9670-1	CAPACITOR: fixed; 670 mmfd, $\pm 1.2\%$; 500 volts d-c working; mica	Oscillator series		
17*	3D9130-1	CAPACITOR: fixed; 130 mmfd, $\pm 5\%$; 500 volts d-c working; silver mica	Oscillator series	RCA	M-420394-10
18-1	3D9500-63	CAPACITOR: fixed; 500 mmfd, $\pm 5\%$; 500 volts d-c working; silver mica	1st I-F transformer secondary tuning	RCA	M-420394-25
18-2		CAPACITOR: Same as 18-1	1st I-F transformer secondary tuning		
19	3D9285	CAPACITOR: fixed; 285 mmfd, $\pm 5\%$; 500 volts d-c working; silver mica	Crystal transformer tuning		
20-1	3D9260-3	CAPACITOR: fixed; 260 mmfd, $\pm 5\%$; 500 volts d-c working; silver mica	2nd I-F transformer primary tuning	RCA	M-420394-19
20-2		CAPACITOR: Same as 20-1	2nd I-F transformer secondary tuning		
20-3		CAPACITOR: Same as 20-1	3rd I-F transformer secondary tuning		
21-1	3D9250-18	CAPACITOR: fixed; 250 mmfd, $\pm 5\%$; 500 volts d-c working; silver mica	1st I-F transformer primary tuning	RCA	M-420394-18
21-2		CAPACITOR: Same as 21-1	3rd I-F transformer primary tuning		
22-1	3D9240-1	CAPACITOR: fixed; 240 mmfd, $\pm 5\%$; 500 volts d-c working; silver mica	C-W oscillator padding	RCA	M-420394-17

* See Part II of this table.

TABLE OF REPLACEABLE PARTS — PART I

MODEL: RADIO RECEIVER BC-348-(*) OR BC-224-(*)

Reference Symbol	Army Stock Number Navy Type Number British Reference Number	Name of Part and Description	Function	Mfr. and Designation	Drawing or Specification No.
22-2		CAPACITOR: Same as 22-1	2nd detector bypass		
23*	3D9170-4	CAPACITOR: fixed; 170 mmfd, $\pm 1.2\%$; 500 volts d-c working; silver mica	Oscillator series.	RCA	P-721286-7
24-1	3D9155	CAPACITOR: fixed; 155 mmfd, $\pm 1.8\%$; 500 volts d-c working; silver mica	Antenna unit series	RCA	M-420394-8
24-2		CAPACITOR: Same as 24-1	R-F unit series		
24-3		CAPACITOR: Same as 24-1	1st detector unit series		
25*	3D9025-31	CAPACITOR: fixed; 25 mmfd, $\pm 5\%$; 500 volts d-c working; silver mica, salt water seal	Antenna unit padding	RCA	P-721286-3
26-1	3D9150-7	CAPACITOR: fixed; 150 mmfd, $\pm 5\%$; 500 volts d-c working; silver mica	C-W oscillator grid	RCA	M-420394-21
26-2		CAPACITOR: Same as 26-1	4th I-F transformer secondary tuning		
27*	3D9135-4	CAPACITOR: fixed; 135 mmfd, $\pm 1.2\%$; 500 volts d-c working; silver mica	Oscillator series		
28-1	3D9135	CAPACITOR: fixed; 135 mmfd, $\pm 2\%$; 500 volts d-c working; silver mica	Antenna unit series	RCA	M-420394-7
28-2		CAPACITOR: Same as 28-1	R-F unit series		
28-3		CAPACITOR: Same as 28-1	1st detector unit series		
29-1*	3D9470-4	CAPACITOR: fixed; 470 mmfd, $\pm 2\%$; 500 volts d-c working; silver mica; salt water seal	Antenna unit series	RCA	P-721286-4
29-2*		CAPACITOR: Same as 29-1	R-F unit series		
29-3*		CAPACITOR: Same as 29-1	1st detector unit series		
30	3D9100-19 (also shipped as 3D9100-55)	CAPACITOR: fixed; 100 mmfd, $\pm 5\%$; 500 volts, d-c working; silver mica	Heterodyne oscillator grid	RCA	M-420394-11
31-1	3D9075-2 (also shipped as 3D9075-4)	CAPACITOR: fixed; 75 mmfd, $\pm 5\%$; 500 volts, d-c working; silver mica	R-F unit paddler	RCA	M-420394-9

* See Part II of this table.

TABLE OF REPLACEABLE PARTS — PART I

MODEL: RADIO RECEIVER BC-348-(*) OR BC-224-(*)

Reference Symbol	Army Stock Number Navy Type Number British Reference Number	Name of Part and Description	Function	Mfr. and Designation	Drawing or Specification No.
31-2		CAPACITOR: Same as 31-1	1st detector unit padder		
31-3		CAPACITOR: Same as 31-1	Diode coupling		
31-4		CAPACITOR: Same as 31-1 (not used in BC-348-E, M, P)	Diode coupling		
32	3D9047 (also shipped as 3D9047-1)	CAPACITOR: fixed; 47 mmfd, $\pm 5\%$; 500 volts d-c working; silver mica	4th I-F transformer primary tuning	RCA	M-420394-22
33-1*	3D9050-7	CAPACITOR: fixed; 50 mmfd, $\pm 5\%$; 500 volts d-c working; silver mica	Antenna unit padder	RCA	P-721286-1
33-2*		CAPACITOR: Same as 33-1	R-F unit padder		
33-3*		CAPACITOR: Same as 33-1	1st detector unit padder		
34	3D9085	CAPACITOR: fixed; 85 mmfd, $\pm 2.5\%$; 500 volts d-c working; zero temperature coefficient; ceramic	Oscillator temperature compensating	Stromberg-Carlson	D-4053
35	3D9047-1 (also shipped as 3D9047-6 and 3D9047-1.1)	CAPACITOR: fixed; 47 mmfd, $\pm 5\%$; 500 volts d-c working; zero temperature coefficient; ceramic	Oscillator temperature compensating	RCA Stromberg-Carlson	M-420506-2 D-4052
36*	3D9030-5.1 (also shipped as 3D90-54)	CAPACITOR: fixed; 30 mmfd, $\pm 2.5\%$; 500 volts d-c working; negative temperature coefficient; ceramic	Oscillator temperature compensating	RCA	M-428801-22
37-1	3D9025V-6 (also shipped as 3DF98)	CAPACITOR: variable; 4 to 25 mmfd; 7 plates	R-F unit trimmer	Stromberg-Carlson	D-5023
37-2		CAPACITOR: Same as 37-1	1st detector unit trimmer		
38-1A	3DA500-42 (also shipped as 3DA500-60)	CAPACITOR: fixed; 0.5 mfd x 0.5 mfd (dual) $\pm 15\%$; 250 volts d-c working; oil paper; solder lug bent down 15°; flat mounting base	4th I-F transformer filter	RCA	M-420505-1
38-1B		CAPACITOR: Same as 38-1A	Volume control filter		
38-2A		CAPACITOR: Same as 38-1A	Screen voltage filter		
38-2B		CAPACITOR: Same as 38-1A	Output plate filter		

* See Part II of this table.

TABLE OF REPLACEABLE PARTS — PART I

MODEL: RADIO RECEIVER BC-348-(*) OR BC-224-(*)

Reference Symbol	Army Stock Number Navy Type Number British Reference Number	Name of Part and Description	Function	Mfr. and Designation	Drawing or Specification No.
38-3A		CAPACITOR: Same as 38-1A	Noise compensator filter		
38-3B		CAPACITOR: Same as 38-1A	1st I-F screen filter	RCA	M-420505-2
39-1A	3DA500-47 (also shipped as 3DA500-89 and 3DA500-61)	CAPACITOR: fixed; 0.5 mfd x 0.5 mfd (dual) $\pm 5\%$; 250 volts d-c working; oil paper; solder lugs bent up 15°	4th I-F transformer filter		
39-1B		CAPACITOR: Same as 39-1A	4th I-F transformer filter		
39-2A		CAPACITOR: Same as 39-1A	Output grid filter		
39-2B		CAPACITOR: Same as 39-1A	Screen voltage filter		
39-3A		CAPACITOR: Same as 39-1A	1st I-F screen filter		
39-3B		CAPACITOR: Same as 39-1A	3rd I-F screen filter		
40-1	3Z6047 or 3Z6047-5	RESISTOR: fixed; 470 ohms, $\pm 10\%$; 1/2 watt; carbon	1st R-F cathode	RCA	K-850981-58
40-2		RESISTOR: Same as 40-1	2nd R-F cathode		
40-3		RESISTOR: Same as 40-1	1st R-F cathode		
40-4		RESISTOR: Same as 40-1	2nd R-F cathode		
41-1	3Z4525 or 3Z6100-58	RESISTOR: fixed; 1000 ohms, $\pm 10\%$; 1/2 watt; carbon	Oscillator plate	RCA	K-850981-62
41-2		RESISTOR: Same as 41-1	3rd I-F cathode		
41-3		RESISTOR: Same as 41-1 (used only in Radio Receivers BC-348-E, BC-348-M, BC-348-P)	1st R-F primary		
42-1	3Z6470-2 or 3Z6470-8	RESISTOR: fixed; 4700 ohms, $\pm 10\%$; 1/2 watt; carbon	1st R-F plate	RCA	P-28166
42-2		RESISTOR: Same as 42-1	2nd R-F plate		
42-3		RESISTOR: Same as 42-1	1st detector plate		
42-4		RESISTOR: Same as 42-1	1st I-F screen		
42-5		RESISTOR: Same as 42-1	1st I-F plate		
42-6		RESISTOR: Same as 42-1	Bleeder		

TABLE OF REPLACEABLE PARTS — PART I

MODEL: RADIO RECEIVER BC-348-(*) OR BC-224-(*)

Reference Symbol	Army Stock Number Navy Type Number British Reference Number	Name of Part and Description	Function	Mfr. and Designation	Drawing or Specification No.
42-7		RESISTOR: Same as 42-1	3rd I-F cathode		
42-8		RESISTOR: Same as 42-1 (used only in Radio Receivers BC-348-E, BC-348-M, BC-348-P)	Voltage regulator series		
43-1	3Z6610-49 or 3Z6610-57	RESISTOR: fixed; 10,000 ohms, $\pm 10\%$; $\frac{1}{2}$ watt; carbon	1st R-F screen	RCA	K-850981-74
43-2		RESISTOR: Same as 43-1	2nd R-F screen		
43-3		RESISTOR: Same as 43-1	1st detector screen		
43-4		RESISTOR: Same as 43-1	C-W oscillator bleeder		
44††	3Z6612-1 (also shipped as 3Z6612-7)	RESISTOR: fixed; 12,000 ohms, $\pm 10\%$; $\frac{1}{2}$ watt; carbon	Voltage regulator series	RCA	K-850981-75
45	3Z6615-25 or 3Z6615-26	RESISTOR: fixed; 15,000 ohms, $\pm 10\%$; $\frac{1}{2}$ watt; carbon	1st detector cathode	RCA	K-850981-76
46	3Z6656-1 or 3Z6656-3	RESISTOR: fixed; 56,000 ohms, $\pm 10\%$; $\frac{1}{2}$ watt; carbon	Output loading	RCA	K-850981-83
47	3Z6668 or 3Z6668-3	RESISTOR: fixed; 68,000 ohms, $\pm 10\%$; $\frac{1}{2}$ watt; carbon	C-W oscillator plate	RCA	K-850981-84
48-1	3Z4550 or 3Z6700-61	RESISTOR: fixed; 100,000 ohms, $\pm 10\%$; $\frac{1}{2}$ watt; carbon	1st R-F grid	RCA	K-850981-86
48-2		RESISTOR: Same as 48-1	2nd R-F grid		
48-3		RESISTOR: Same as 48-1	Oscillator grid		
48-4		RESISTOR: Same as 48-1	Output grid filter		
48-5		RESISTOR: Same as 48-1 (used only in Radio Receivers BC-348-E, BC-348-M, BC-348-P)	Bias control		
49	3Z6718 or 3Z6718-3	RESISTOR: fixed; 180,000 ohms, $\pm 10\%$; $\frac{1}{2}$ watt; carbon	3rd I-F screen	RCA	K-850981-89
50-1	3Z6747-1 or 3Z6747-6	RESISTOR: fixed; 470,000 ohms, $\pm 10\%$; $\frac{1}{2}$ watt; carbon	Antenna protective	RCA Centralab type 710 or AB type EB	K-850981-94

††Used in Radio Receivers BC-224-E, BC-224-G, BC-224-H, BC-224-L, BC-348-O, BC-348-S.

TABLE OF REPLACEABLE PARTS — PART I

MODEL: RADIO RECEIVER BC-348-(*) OR BC-224-(*)

Reference Symbol	Army Stock Number Navy Type Number British Reference Number	Name of Part and Description	Function	Mfr. and Designation	Drawing or Specification No.
50-2		RESISTOR: Same as 50-1	1st I-F grid		
50-3		RESISTOR: Same as 50-1	2nd I-F grid		
50-4		RESISTOR: Same as 50-1	C-W oscillator grid		
51	3Z6756-1 or 3Z6756-5	RESISTOR: 560,000 ohms, $\pm 10\%$; $\frac{1}{2}$ watt; carbon; insulated	Output grid	RCA Centralab type 710 or AB type EB	K-850981-95
52	3Z6801A5	RESISTOR: fixed; 1.5 megohms, $\pm 10\%$; $\frac{1}{2}$ watt; carbon; insulated; axial leads	AVC diode	RCA Centralab type 710 or AB type EB	K-850981-100
53	3Z6722-1 or 3Z6722-5	RESISTOR: fixed; 220,000 ohms, $\pm 10\%$; $\frac{1}{2}$ watt; carbon; axial leads	AVC filter	RCA Centralab type 710 or AB type EB	K-850981-90
54†	3Z5985 (also shipped as 3Z6750-5)	RESISTOR: fixed; 0.5 ohm, $\pm 10\%$; 1 watt; wire wound; insulated; axial leads	Filament	RCA	K-845949-32
56*	3Z6610-11 (also shipped as 3Z6610-48)	RESISTOR: fixed; 10,000 ohms, $\pm 10\%$; 1 watt; carbon; insulated; axial leads	Bleeder	RCA	K-844314-79
57*	3Z6627-3	RESISTOR: fixed; 27,000 ohms, $\pm 10\%$; 1 watt; carbon; insulated; axial leads	Voltage regulator series resistor	IRC type BT- $\frac{1}{2}$	K-844314-79
58	2Z7299M3.5 (also shipped as 3Z6350-2)	RESISTOR: variable; 3500 ohms, $\pm 10\%$; $\frac{1}{10}$ watt; metallized; carbon	Noise compensator	IRC type CS Curve A	K-854157-1
59-A	2Z7284-8 (also shipped as 2ZF3634, 2C4348H/R1 and 2C4224B/6)	POTENTIOMETER: two-section gang; front section 20,000 ohms; rear section 350,000 ohms; power rating .2 watt for each section; carbon; linear taper; secured by hex nut	Volume control for MVC	IRC type BT-1	M-420382-1
59-B		POTENTIOMETER: Same as 59-A	Volume control for MVC		

† Used only in Radio Receivers BC-224-E, BC-224-G, BC-224-H, BC-224-L.

* See Part II of this table.

TABLE OF REPLACEABLE PARTS — PART I

MODEL: RADIO RECEIVER BC-348-(*) OR BC-224-(*)

Reference Symbol	Army Stock Number Navy Type Number British Reference Number	Name of Part and Description	Function	Mfr. and Designation	Drawing or Specification No.
60† or 60‡	3Z7075 (also shipped as 2C4348H/R2 or 3Z7200-4 (also shipped as 2C4348H/R2 and 2C4348M/R2)	RESISTOR: 75 ohms, $\pm 10\%$; wire wound; open circuit when in a full counter-clockwise position RESISTOR: 200 ohms; 4 watts; variable (used only in BC-348-O and BC-348-S)	Dial lamp control	RCA	K-855754-1
61	3Z6240 or 3Z6240-8	RESISTOR: fixed; 2400 ohms, $\pm 5\%$; 1/2 watt; carbon; axial leads	Output plate	RCA	K-850981-168
62	3Z6647-1 (also shipped as 3Z6647-4 or 3Z6647-5)	RESISTOR: fixed; 47,000 ohms, $\pm 10\%$; 1/2 watt; insulated; axial leads	Bleeder	RCA Centralab type 710 or AB type EB	K-850981-82
64*	3DK9035-11	CAPACITOR: fixed; ceramic; 35 mmfd, $\pm 5\%$; 500 volts d-c working; axial leads	Oscillator temperature compensating	RCA	M-428801-21
66*	3D9050V-46	CAPACITOR: adjustable; air; 5 to 50 mmfd; 1 stationary plate, 1 variable plate; pure silver on ceramic; screw-type adjustment	Oscillator series	RCA	K-871390-1
67	3DK9750-10 (also shipped as 3D9750-8)	CAPACITOR: fixed; 750 mmfd, $\pm 5\%$; 500 volts d-c working; silvered mica; low loss; salt water seal; molded bakelite case	R-F unit paddler	RCA	P-721286-2
101-A*	2C4348H/C4 (also shipped as 2C4224B/C5)	TRANSFORMER ASSEMBLY: audio; consists of 1 audio transformer, 1 audio-frequency choke, 1 capacitor at 50,000 mmfd, 400 volts d-c working	Output	RCA	K-901387-501
101-B*		TRANSFORMER ASSEMBLY: Same as 101-A	Filter		
101-C*		TRANSFORMER ASSEMBLY: Same as 101-A	C-W oscillator time constant		
102-1	2Z5534-B (also shipped as 2C4348H/J1 2C4348M/J1 and 2Z5534)	JACK: open circuit; single circuit; cadmium plated spring steel contacts; 2 solder lug terminals mounted on rear	Headphone	RCA	K-830654-1

† Used only in Radio Receivers BC-224-E, BC-224-G, BC-224-H, BC-224-L.

‡ Used only in Radio Receivers BC-348-O, BC-348-S.

* See Part II of this table.

TABLE OF REPLACEABLE PARTS — PART I

MODEL: RADIO RECEIVER BC-348-(*) OR BC-224-(*)

Reference Symbol	Army Stock Number Navy Type Number British Reference Number	Name of Part and Description	Function	Mfr. and Designation	Drawing or Specification No.
102-2		JACK: Same as 102-1	Headphone		
103	2J991 or 2V991	TUBE: vacuum; type JAN-991; glow discharge type; minimum starting voltage 87; working voltage 48 to 67 volts; max. peak current 3 milliamperes; continuous operating current 2 milliamperes	Oscillator plate voltage regulator	RCA	991
104	2Z5927	LAMP LM-27: bayonet base; 6.3 volts; .25 ampere; type 44	Dial lamp	GE	K-854707-1
105	3Z9692-1561.1	SWITCH: rotary snap type; SPST; 2 positions; contacts rated 3 amperes at 125 volts	Crystal filter (on-off)	AHH	K-854320-1
105-A	6L3506-32.5	NUT: hexagon; thickness 5/64"; brass, dull nickel finish	Fastener for ref. 105		K-866504-1
106*	3Z9858-1	SWITCH: lever; DPST; two-position; contacts rated 1 ampere at 250 volts; secured by hex nut threaded to shaft housing	C-W osc. (on-off)	AHH	
107	3Z9825-1 (also shipped as 2C4224F/S3)	SWITCH: rotary; 2-section; 3-position; 2-wafer	AVC-OFF-MVC	Oak Special	M-420381-1
108*	2C4224F/S4	SWITCH: rotary; 2-section; special contact constructions; six-position; contacts silver plated; sections of wax impregnated bakelite	Antenna band selector	P. R. Mallory Special	M-422371-1
109*		SWITCH: Same as 108	Antenna band selector		
110*	2C4224F/S5	SWITCH: rotary; 2-section; special contact constructions; 6-position; contacts silver plated; sections of wax impregnated bakelite	R-F band selector	P. R. Mallory Special	RCA M-420372-1
111*		SWITCH: Same as 110	R-F band selector		
112*		SWITCH: Same as 110	Detector band selector		
113*		SWITCH: Same as 110	Detector band selector		
114*	3Z8190	SWITCH: rotary; 4-section; 4 circuits; 6 positions; special contact shorting arrangement in sections 3 and 4; silver plated contacts; sections of wax impregnated bakelite	Oscillator band selector	P. R. Mallory Special	RCA M-420371-1
115*		SWITCH: Same as 114	Oscillator band selector		

* See Part II of this table.

TABLE OF REPLACEABLE PARTS — PART I

MODEL: RADIO RECEIVER BC-348-(*) OR BC-224-(*)

Reference Symbol	Army Stock Number Navy Type Number British Reference Number	Name of Part and Description	Function	Mfr. and Designation	Drawing or Specification No.
116*		SWITCH: Same as 114	Oscillator band selector		
117*		SWITCH: Same as 114	Oscillator band selector		
118† or 118‡	3Z1923 or 3Z1935	FUSE: FU-23; 10 amperes; 25 volts; cartridge type FUSE: FU-35; 5 amperes; 25 volts	Primary power fuse	Littelfuse type 4AG	K-850339-2
119	3Z635 (also shipped as 2C4224F/P1 and 2C4224C/B12)	BINDING POST: spring type; dimensions 1 ²¹ / ₃₂ " length by 1/2" diameter; brass shank with bakelite covered top; single hole mounting thru hole 5/32" dia; letter "A" stamped on top	Antenna connector	American Radio Hardware order under RCA Dwg. No. K-854468-4	RCA K-854468-4
120	3Z635-1 (also shipped as 2C4224F/P2 and 2C4224C/B13)	BINDING POST: spring type; dimensions, 2 ¹ / ₃₂ " length by 1/2" diameter; brass shank with bakelite covered top; single hole mounting through hole 5/32" dia; letter "G" stamped on top	Ground connector	American Radio Hardware order under RCA Dwg. No. K-854468-5	RCA K-854468-5
201	6Z5018 (also shipped as 2C4348H/H1 and 2C4348M/H1 and 2C4224B/H1)	HANDLE: brass 1/8" thick; U-shaped; 2 mounting holes 0.203" dia mounting centers 3" apart, dull black nickel finish	Front panel	National Lock Cat. #0130 modified by RCA	RCA K-854382-1
202	2Z6190 (also shipped as 2C4348H/L1 and 2C4224B/L10)	LEVER: control type; die cast aluminum alloy; single fin protrudes from bar to form handle; mounts on 1/4" shaft; secured by single set screw	AVC-MVC switch lever	RCA special	RCA K-854387-1
202-A	6L7960-3	SCREW: Set; #8-32 thread; 1/4" long; steel; cup point on end; hollow hex head machined for #6 Allen wrench	Set screw for knob #202	Allen	RCA K-843365-13
203	2Z5748.1 (also shipped as 2C4348H/K2, 2Z5748.2, 2Z5839 and 2Z5841-4)	KNOB: control type; die cast aluminum alloy; knurled periphery; mounts on 1/4" shaft secured by single set screw	Control knob for antenna alignment capacitor, crystal switch dial lamp intensity control and volume control	RCA K-854352-1	RCA K-854352-1
203-A	6L7960-2	SCREW: Set; #8-32 thread; 3/16" long; steel; cup point on end; hollow hex head machined for #6 Allen wrench	Set screw for knob #203	Allen	RCA K-843365-12

† Used only in Radio Receivers BC-224-E, BC-224-G, BC-224-H, BC-224-L.

‡ Used only in Radio Receivers BC-348-O, BC-348-S.

* See Part II of this table.

TABLE OF REPLACEABLE PARTS — PART I

MODEL: RADIO RECEIVER BC-348.(*) OR BC-224.(*)

Reference Symbol	Army Stock Number Navy Type Number British Reference Number	Name of Part and Description	Function	Mfr. and Designation	Drawing or Specification No.
204	2Z5748.2 (also shipped as 2C4348H/K3, 2Z5842-1 and 2Z5841-6)	<p>KNOB ASSEMBLY: control type; die cast aluminum alloy; knurled periphery; mounts on 1/4" shaft; secured by 2 set screws; overall dimensions 9/16" thick by 1/4" diameter</p> <p>SCREW: Same as 203A</p> <p>SCREW: thumb; #6-32 thread; 3/32" long; brass; straight knurled head measuring 7/16" diameter; dull black nickel finish</p>	C-W oscillator frequency control	RCA K-854352-3	RCA K-854352-3
204-A		SCREW: Same as 203A	Set screw for knob #204		
205	6L7986-16.8	SCREW: thumb; #6-32 thread; 3/32" long; brass; straight knurled head measuring 7/16" diameter; dull black nickel finish	Secures dial escutcheon	RCA K-833028-2	RCA K-833028-2
206	2Z5748.3	KNOB: control type; die cast aluminum alloy; six fins protruding from face of knob; mounts on 1/4" shaft; secured by single set screw; overall dimensions 1 1/16" thick by 1 3/4" diameter	Control knob for band switch	RCA K-854417-1	RCA K-854417-1
206-A		SCREW: Same as 202-A	Set screw for knob #206		
207	2Z5748	KNOB ASSEMBLY: consists of KNOB: control type; aluminum alloy construction; overall dimensions 3/4" thick by 2 1/8" diameter HANDLE: crank type; duraluminum construction TUBING SLEEVE: laminated insulation material; slides over shaft to insulate crank handle from tuning shaft.	Tuning control	RCA Special	RCA K-833518-504
208	2Z7093-2	COVER PLATE: aluminum; black wrinkle finish; overall dimensions 6 1/16" x 2.187" x 0.064"; six mounting holes along outer edges of plate; size of holes 0.154" diameter	Covers tube shelf across cutout	RCA K-854427-1 Special	RCA K-854427-1
209	2C4224B/S1	SCREW: machine; #8-32 thread; 7/16" long; stainless steel; screwdriver slotted head measuring 1/8" width by 3/8" diameter	Used on main tuning gang	RCA K-837861-1	RCA K-837861-1
210	6L6832-9.7A	SCREW: machine; #8-32 thread; 1 3/16" long; brass nickel finish; screwdriver slotted head measuring 7/16" diameter	Dynamotor mounting	RCA K-850612-3	RCA K-850612-3
211	2C4224B/S3	SCREW: machine; #8-32 thread; 1 3/16" long; stainless steel; screwdriver slotted round head measuring 0.298" diameter	Dynamotor mounting	RCA K-850626-1	RCA K-850626-1
212	2C4224B/S4	SCREW: machine; #10-32 thread; 3/4" long; stainless steel; hex head measuring 3/8" across flats; screwdriver slot	Secures dial assembly to chassis	RCA K-854496-1	RCA K-854496-1

TABLE OF REPLACEABLE PARTS — PART I

MODEL: RADIO RECEIVER BC-348-(*) OR BC-224-(*)

Reference Symbol	Army Stock Number Navy Type Number British Reference Number	Name of Part and Description	Function	Mfr. and Designation	Drawing or Specification No.
213	6L6440-4.6A	SCREW: machine #4-40 thread; $\frac{3}{16}$ " long; stainless steel	Secures plug to mounting plate	RCA K-833571-1	RCA K-833571-1
214	2C4224B/20 (also shipped as 2C4348H/C14 and 2C4348M/C4)	COVER ASSEMBLY: consists of COVER: panel type; 2 aluminum plates spot-welded together; thickness of each plate 0.032". BUSHING: brass, staked to cover; $\frac{3}{8}$ " thick x $\frac{5}{16}$ " diameter LOCK: thumbscrew type; fits through brass bushing in cover and serves to lock panel in place. Assembly $1\frac{3}{16}$ " x $2\frac{1}{4}$ " x $2\frac{7}{32}$ " overall	Cover for oscillator box	RCA K-854451-501 Special	RCA K-854451-501
215	2Z11100 (also shipped as 2C4348H/S15 and 2C4348M/S3)	SHIELD: tube; aluminum; material 0.015" thick; $\frac{3}{4}$ " long x $1\frac{1}{16}$ " diameter; buffed finish	Shield for tube VT-70	Aluminum Goods Co. order under RCA dwg. #K-854420-1	RCA K-854420-1
216† or 216‡	3Z3285-5 or 3Z2909 (also shipped as 2C4348H/C5 and 2C4348M/F2 and 3Z2910)	FUSE MOUNTING: bakelite composition base; 2 cadmium plated phosphor bronze fuse clips; $\frac{2}{8}$ " x $\frac{1}{2}$ " x $\frac{5}{16}$ " overall; mounting centers $2\frac{1}{2}$ " apart FUSE CLIP: fuse clip; board assembly; primary supply fuse; stamped FU-35	Mounting for primary supply fuse	RCA K-854457-501	RCA K-854457-501
217	2Z8670.3	SOCKET: tube; wax impregnated bakelite; octal base; riveting plate mounting; mounting centers $1\frac{1}{2}$ " apart	For tubes VT-91, VT-86, VT-93, VT-65	A. W. Franklin order under RCA dwg. No. K-82747-15	RCA K-82747-15
218	2C4224B/21	SOCKET: bayonet type; polystyrene and bakelite material used in contact insulator; two insert type contacts; secured to panel with two machine screws; mounting centers, $1\frac{3}{16}$ " apart	Located in voltage regulator unit	L. C. Herse Special order under RCA Dwg. No. K-837884-2	RCA K-837884-2
219	2Z8688-1	SOCKET: tube; wax impregnated bakelite; seven receptacle contacts; riveting plate mounting; mounting centers, $\frac{13}{8}$ " apart	Socket for tube VT-48	RCA K-854466-1	RCA K-854466-1
220	2Z8669	SOCKET: tube; wax impregnated bakelite; seven receptacle contacts; riveting plate mounting; mounting centers $\frac{13}{8}$ " apart	Socket for tube VT-70	RCA K-854466-2	RCA K-854466-2

† Used only in Radio Receivers BC-224-E, BC-224-G, BC-224-H, BC-224-L.

‡ Used only in Radio Receivers BC-348-O, BC-348-S.

TABLE OF REPLACEABLE PARTS — PART I

MODEL: RADIO RECEIVER BC-348-(*) OR BC-224-(*)

Reference Symbol	Army Stock Number Navy Type Number British Reference Number	Name of Part and Description	Function	Mfr. and Designation	Drawing or Specification No.
222	2Z3084	PLUG: straight; eight pin contacts; nickel plated; contact size number 18; overall dimensions $2\frac{1}{8}$ " x $1\frac{1}{16}$ " x $1\frac{29}{32}$ "	Power connector plug	RCA K-854447-502 Special	RCA K-854447-502
251*	2C4224B/9	TRANSFORMER ASSEMBLY: i-f consists of TRANSFORMER: i-f; 915 kc; two windings; each winding made up of 4 pie sections; primary 23 turns per section or 92 turns per winding; secondary 23 turns per section or 92 turns per winding; number 41 enameled double silk-covered wire; primary inductance 69 microhenries; primary Q101 at 1500 kc; secondary Q98 at 1500 kc; universal wound; distance between windings $\frac{3}{8}$ "; wound on laminated coil form $\frac{1}{2}$ " diameter; entire coil wax impregnated; adjustable iron core in both windings; CAPACITOR: three fixed types; entire unit factory assembled in metal case; overall dimensions $4\frac{1}{2}$ " x $1\frac{1}{16}$ " x $1\frac{1}{8}$ "; mounting centers $1\frac{3}{8}$ " apart	1st I-F transformer	RCA K-720237-501	RCA P-720237-501
252*	2C4224B/10	TRANSFORMER ASSEMBLY: i-f consists of TRANSFORMER: i-f; 915 kc; two windings; each winding made up of 4 pie sections; primary 23 turns per section or 92 turns per winding; secondary 23 turns per section or 92 turns per winding; number 41 enameled double silk-covered wire; primary inductance 69 microhenries; secondary inductance 69 microhenries; primary Q101 at 1500 kc; secondary Q101 at 1500 kc; universal wound; distance between windings $1\frac{1}{32}$ "; wound on laminated coil form $\frac{1}{2}$ " diam; entire coil wax impregnated; adjustable iron core in both windings; CAPACITOR: two fixed types; entire unit factory assembled in metal case; $4\frac{1}{2}$ " x $1\frac{1}{16}$ " x $1\frac{1}{8}$ " overall; mounting centers $1\frac{3}{8}$ " apart	2nd I-F transformer	RCA P-720237-502	RCA P-720237-502
253*	2C4224B/11	TRANSFORMER ASSEMBLY: i-f consists of TRANSFORMER: i-f; 915 kc; two windings; each winding made up of 4 pie sections; primary 23 turns per section or 92 turns per winding; secondary 23 turns per section or 92 turns per winding; number 41 enameled double silk-covered wire; primary inductance 69 microhenries; secondary inductance 69 microhenries; primary Q101 at 1500 kc; secondary Q101 at 1500 kc; universal wound; distance between windings $1\frac{1}{32}$ "; wound on laminated coil form $\frac{1}{2}$ " diam; entire coil wax impregnated; adjustable iron core in both windings; CAPACITOR: two fixed types; entire unit factory assembled in metal case; $4\frac{1}{2}$ " x $1\frac{1}{16}$ " x $1\frac{1}{8}$ " overall; mounting centers $1\frac{3}{8}$ " apart	3rd I-F transformer	RCA P-720237-503	RCA P-720237-503

* See Part II of this table.

TABLE OF REPLACEABLE PARTS — PART I

MODEL: RADIO RECEIVER BC-348-(*) OR BC-224-(*)

Reference Symbol	Army Stock Number Navy Type Number British Reference Number	Name of Part and Description	Function	Mfr. and Designation	Drawing or Specification No.
254*	2C4224B/13	<p>eled double silk-covered wire; primary inductance 69 microhenries; secondary inductance 69 microhenries; primary Q101 at 1500 kc; secondary Q101 at 1500 kc; universal wound; distance between winding $1\frac{7}{32}$"; wound on laminated coil form $\frac{1}{2}$" diameter; entire coil wax impregnated; adjustable iron core in both windings;</p> <p>CAPACITORS: two fixed types; entire unit factory-assembled in metal case; overall dimensions $4\frac{1}{2}$" x $1\frac{1}{16}$" x $1\frac{3}{8}$"; mounting centers $1\frac{3}{8}$" apart</p> <p>TRANSFORMER ASSEMBLY: i-f consists of TRANSFORMER: i-f; 915 kc; two windings; each winding is made of 4 pie sections; primary 50 turns per section or 200 turns per winding; secondary 30 turns per section or 120 turns per winding; number 41 enameled double silk-covered wire; primary inductance 340 microhenries; secondary inductance 122 microhenries; primary Q126 at 700 kc; secondary Q102 at 1200 kc; universal wound; distance between windings $\frac{9}{16}$"; wound on laminated coil form $\frac{1}{2}$" diameter; entire coil wax impregnated; adjustable iron core in both windings;</p> <p>CAPACITORS: two fixed types; entire unit factory-assembled in metal case; overall dimensions $4\frac{1}{2}$" x $1\frac{1}{16}$" x $1\frac{5}{8}$"; mounting centers $1\frac{3}{8}$" apart</p>	4th I-F transformer	RCA P-720237-504	RCA P-720237-504
255*	2Z3419.1	CRYSTAL FILTER ASSEMBLY: consists of one 915 kc crystal; one crystal holder; one transformer; one adjustable capacitor; one fixed capacitor; 1 SPST switch; factory-assembled in metal case; overall dimensions $4\frac{3}{8}$ " x $1\frac{7}{8}$ " x $1\frac{3}{4}$ "; secured by one spade bolt at each side of case; distance between mounting centers $1\frac{3}{8}$ "	Crystal selectivity filter	RCA M-420376-501	RCA M-420376-501
256*	2C4224H/C2	TRANSFORMER ASSEMBLY: c-w oscillator; 915 kc; consists of one 3-section oscillator transformer; two fixed capacitors; one variable capacitor; one resistor; factory-assembled in metal case; overall dimensions $4\frac{1}{2}$ " x $1\frac{1}{16}$ " x $1\frac{5}{8}$ "; secured by one spade bolt at each end of case; distance between mounting centers $1\frac{3}{8}$ "	C-W oscillator transformer	RCA M-420377-501	RCA M-420377-501

* See Part II of this table.

TABLE OF REPLACEABLE PARTS — PART I

MODEL: RADIO RECEIVER BC-348-(*) OR BC-224-(*)

Reference Symbol	Army Stock Number Navy Type Number British Reference Number	Name of Part and Description	Function	Mfr. and Designation	Drawing or Specification No.
257*	2C4224H/C5	COIL ASSEMBLY: antenna; consists of 5 adjustable capacitors; one fixed capacitor; 6 trimmers; one fixed resistor; six coils; one two-section switch; housed in aluminum case; overall dimensions $7\frac{3}{8}$ " x 2" x $5\frac{5}{8}$ "; entire assembly put together at factory	Couples antenna to 1st R-F	RCA P-721189-501	RCA P-721189-501
258*	2C4224H/C1	TRANSFORMER ASSEMBLY: r-f; designed for BC-224; consists of six r-f transformers; fourteen capacitors; two resistors; one two-section rotary switch; factory-assembled in metal case; overall dimensions $7\frac{3}{8}$ " x 2" x $5\frac{5}{8}$ "; two mounting holes at each end of case; distance between mounting centers 5.312"	1st R-F transformer	RCA P-721189-501	RCA P-721189-501
259*	2C4224H/C4 (also shipped as 2C4224B/C4)	TRANSFORMER ASSEMBLY: detector; consists of six r-f transformers; twelve capacitors; one resistor; two switches; factory-assembled in metal case; overall dimensions $7\frac{3}{8}$ " x 2" x $5\frac{5}{8}$ "; two mounting holes at each end of case; distance between mounting centers 5.312"	2nd R-F transformer and detector transformer	RCA P-721189-502	RCA P-721189-502
260*	2C4224H/C3	TRANSFORMER ASSEMBLY: oscillator; consists of six oscillator transformers; twenty capacitors; three resistors; one four-section rotary switch; factory-assembled in metal case; overall dimensions $7\frac{3}{8}$ " x 2" x $5\frac{5}{8}$ "; two mounting holes at each end of case; distance between mounting centers $5\frac{3}{4}$ "	Heterodyne oscillator transformer	RCA P-721187-501	RCA P-721187-501
300†	3H1624-()	DYNAMOTOR: 13.8 volts; 2.45 amperes; 220 volts; 0.070 amperes; 4400 rpm	Motor generator		
301*	3C370-1 (also shipped as 2C4348M/C2 2C4348H/C2 2C4224B/7 and 3H1628E/C1)	COIL: choke; filter 300 turns; #30 AWG enameled silk-covered; universal wound 4 crosses per turn; wound on maple or birch form measuring $\frac{7}{16}$ " long x $\frac{1}{2}$ " diameter; base constructed of laminated insulation cloth and supports two solder lug terminals; overall dimensions $1\frac{1}{16}$ " x $1\frac{3}{16}$ " x $1\frac{3}{16}$ "; wax impregnated	Filter choke for dynamotor	RCA K-850610-501	RCA K-850610-501
302*	3C370-2 (also shipped as 2C4224B/8 2C4348M/C1 2C4348H/C1 and 3H1628E/C2)	COIL: choke; r-f; 75 turns; #15 AWG enameled; layer wound; wound on maple or birch form measuring $\frac{3}{4}$ " long by $\frac{1}{2}$ " diameter; inductance 83 microhenries; d-c resistance 0.006 ohms; $\pm 5\%$ —10%; overall dimensions $\frac{3}{4}$ " length x $1\frac{1}{16}$ " diam; mounts by a $\frac{1}{4}$ " bolt threaded into end of coil form; solder lug terminal at each end of coil form	R-F choke for dynamotor	RCA M-66347-501	RCA M-66347-501

† Used only in Radio Receivers BC-224-E, BC-224-G, BC-224-H, BC-224-L.

* See Part II of this table.

TABLE OF REPLACEABLE PARTS — PART I

MODEL: RADIO RECEIVER BC-348-(*) OR BC-224-(*)

Reference Symbol	Army Stock Number Navy Type Number British Reference Number	Name of Part and Description	Function	Mfr. and Designation	Drawing or Specification No.
303-A	3DA500-43 (also shipped as 3DA500-62)	CAPACITOR: fixed; oil; two-section; 500,000—50,000 micromicrofarads; 250 volts d-c working; tolerance $\pm 20\%$; metal case; overall dimensions $2\frac{3}{8}$ " x $1\frac{1}{16}$ " x $1\frac{1}{4}$ "; 2 solder lug terminals located on one end of case; no mounting bracket CAPACITOR: same as 303-A	Filter for dynamotor	RCA M-420505-3	RCA M-420505-3
303-B	3DB1.361	CAPACITOR: fixed; oil; 1 microfarad; 400 volts d-c working; tolerance $\pm 20\%$; metal case; overall dimensions $2\frac{3}{8}$ " x $1\frac{1}{16}$ " x $1\frac{1}{4}$ "; two solder lug terminals located on one end of case; no mounting bracket	Filter for dynamotor	RCA M-420505-4	RCA M-420505-4
306†	3H1624F/A1 (also shipped as 3H1624H/A1 and 3H1624H/A2) 3H1628H/A1 (also shipped as 3H1628M/A1)	ARMATURE ASSEMBLY: complete with bearings mounted; commutator dimensions $\frac{7}{16}$ " length x 0.968" diameter; distance between bearing shoulders $4\frac{3}{16}$ "; overall dimensions $5\frac{1}{16}$ " length x 1.903" diameter; input 13.8 volts at 2.45 amperes; output 220 volts at 70 milliamperes; operating speed 4400 rpm	Dynamotor armature	Eicor 5-1020-A	RCA K-854705-1
307	3H1624F/B1	BEARING: ball; hardened steel; overall dimensions 0.406" length by 0.748" diameter; machined to fit 0.2362" shaft; part of dynamotor	Dynamotor armature bearing	Eicor BRG-103	RCA K-854705-2
308	3H1624F/B3 (also shipped as 3H1628M/B4 and 3H1628E/B2)	BRUSH ASSEMBLY: consists of BRUSH: high voltage; dimensions $\frac{9}{16}$ " x 0.275" x 0.125"; chamfer $\frac{1}{64}$ " x 45°; marked positive (+); SPRING: stainless steel; $1\frac{1}{32}$ " length x 0.2" diam; SHUNT: two strands of copper wire, 264 circular mils; CAP: tinned; identified by "Part No. 101" stamped on side	Positive high voltage brush for dynamotor	Eicor 2-1022A	RCA K-854705-3
309	3H1624F/B4 (also shipped as 3H1628M/B4.1 and 3H1628E/B3)	BRUSH ASSEMBLY: consists of BRUSH: high voltage; dimensions $\frac{9}{16}$ " x 0.275" x 0.125"; chamfer $\frac{1}{64}$ " x 45°; marked negative (-); SPRING: stainless steel; dimensions $1\frac{1}{32}$ " length by 0.2" diam; SHUNT: two strands of copper wire; 264 circular mils; CAP: tinned; identified by "Part No. 114" stamped on side	Negative high voltage brush for dynamotor	Eicor 2-1023A	RCA K-854705-4

† Used only in Radio Receivers BC-224-E, BC-224-G, BC-224-H, BC-224-L.

‡ Used only in Radio Receivers BC-348-O, BC-348-S.

TABLE OF REPLACEABLE PARTS — PART I

MODEL: RADIO RECEIVER BC-348-(*) OR BC-224-(*)

Reference Symbol	Army Stock Number Navy Type Number British Reference Number	Name of Part and Description	Function	Mfr. and Designation	Drawing or Specification No.
310*	3H1624F/B5 (also shipped as 3H1624B/3.1 and 3H1624B/3)	BRUSH ASSEMBLY: consists of BRUSH: low voltage; dimensions $\frac{5}{8}$ " x 0.306" x 0.187"; chamfer $\frac{1}{64}$ " by 45°; marked positive (+); SPRING: stainless steel; dimensions $1\frac{3}{32}$ " length by 0.23" diam; SHUNT: four strands of copper wire, 528 circular mills; CAP: tinned; identified by "Part No. 204" stamped on side	Positive low voltage for dynamotor	Eicor 2-1020A	RCA K-854705-5
311*	3H1624F/B6 (also shipped as 3H1624B/3.1 and 3H1624B/3)	BRUSH ASSEMBLY: consists of BRUSH: low voltage; dimensions $\frac{5}{8}$ " x 0.306" x 0.187"; chamfer $\frac{1}{64}$ " by 45°; marked negative (-); SPRING: stainless steel; dimensions $1\frac{3}{32}$ " length x 0.23" diam; SHUNT: four strands of copper wire; 528 circular mills; CAP: tinned; identified by "Part No. 205" stamped on side	Negative low voltage brush for dynamotor	Eicor 2-1021A	RCA K-854705-6
510**	3H1628-()	DYNAMOTOR: 28 volts; 1.23 amperes; 220 volts; 0.070 amperes; 4400 rpm	Motor generator		

* See Part II of this table.

** Used only in Radio Receivers BC-348-E, BC-348-M, BC-348-O, BC-348-P, BC-348-S

TABLE OF REPLACEABLE PARTS — PART II

MODEL: RADIO RECEIVERS BC-348-E, BC-348-M, BC-348-P ONLY

Reference Symbol	Army Stock Number Navy Type Number British Reference Number	Name of Part and Description	Function	Mfr. and Designation	Drawing or Specification No.
11-1	3DA10-44 (also shipped as 3DA10-95)	CAPACITOR: fixed; mica; 10,000 mmfd; 300 volts d-c working, $\pm 10\%$; molded bakelite case; dimensions 1" length, $\frac{5}{8}$ " wide, $\frac{3}{16}$ " thick; axial leads	Heterodyne oscillator plate by-pass	Cornell-Dubilier Micamold 340 Radio Corp.	Stromberg-Carlson D-3682
11-2		CAPACITOR: same as 11-1	1st detector cathode by-pass		
12	3DA5-18 (also shipped as 3DF2041)	CAPACITOR: fixed; 5000 mmfd, $\pm 10\%$; 300 volts d-c working; silver mica; low loss molded bakelite case; dimensions $\frac{3}{4}$ " x $\frac{3}{4}$ " x $\frac{1}{4}$ "; axial leads	Audio transformer secondary by-pass	Cornell-Dubilier type IR	Stromberg-Carlson D-3932
13	3D9375	CAPACITOR: fixed; 375 mmfd, $\pm 1.5\%$; 500 volts d-c working; silver mica; low loss molded bakelite case; $\frac{3}{4}$ " x $\frac{3}{4}$ " x $\frac{1}{4}$ "; axial leads	Oscillator series	Cornell-Dubilier type 5R Aerovox type 1464 Erie Resistor type K	Stromberg-Carlson D-4383
14	3DA2.240	CAPACITOR: fixed; 2240 mmfd, $\pm 5\%$; 500 volts d-c working; silver mica; low loss molded bakelite case; dimensions $\frac{3}{4}$ " x $\frac{3}{4}$ " x $\frac{1}{4}$ "; axial leads	Oscillator series	Cornell-Dubilier type IR Aerovox type 1464	Stromberg-Carlson D-3564
17	3D9147	CAPACITOR: fixed; 147 mmfd, $\pm 1\%$; 500 volts d-c working; silver mica; low loss molded bakelite case; dimensions $1\frac{1}{16}$ " x $\frac{7}{16}$ " x $\frac{3}{16}$ "; axial leads	Oscillator series	Cornell-Dubilier type 5R	
23	3D9168	CAPACITOR: fixed; 168 mmfd, $\pm 1.2\%$; 500 volts d-c working; silver mica; low loss molded bakelite case; dimensions $1\frac{1}{16}$ " x $\frac{7}{16}$ " x $\frac{3}{16}$ "; axial leads	Oscillator series	Cornell-Dubilier type 5R Erie Resistor type K	Stromberg-Carlson D-4372
25	3D9025-30	CAPACITOR: fixed; 25 mmfd, $\pm 5\%$; 500 volts d-c working; silver mica; low loss molded bakelite case; dimensions $1\frac{1}{16}$ " x $\frac{7}{16}$ " x $\frac{3}{16}$ "; axial leads	Antenna unit paddler	Cornell-Dubilier type 5R Erie K	Stromberg-Carlson D-4398
27	3D9134	CAPACITOR: fixed; 134 mmfd; $\pm 1\%$; 500 volts d-c working; silver mica; low loss molded bakelite case; dimensions $1\frac{1}{16}$ " x $\frac{3}{16}$ " x $\frac{7}{16}$ "; axial leads	Heterodyne oscillator	Cornell-Dubilier type 5R Erie Resistor type K	Stromberg-Carlson D-4357
29-1	3D9460	CAPACITOR: fixed; 460 mmfd; $\pm 2\%$; 500 volts d-c working; silver mica; low loss molded bakelite case; dimensions $1\frac{1}{16}$ " x $\frac{7}{16}$ " x $\frac{3}{16}$ "; axial leads	Antenna unit padding	Cornell-Dubilier Corp. type 5R Erie Resistor type K	Stromberg-Carlson D-4371
29-2		CAPACITOR: same as 29-1	R-F unit padding		
29-3		CAPACITOR: same as 29-1	1st detector unit		

TABLE OF REPLACEABLE PARTS — PART II

MODEL: RADIO RECEIVERS BC-348-E, BC-348-M, BC-348-P ONLY

Reference Symbol	Army Stock Number Navy Type Number British Reference Number	Name of Part and Description	Function	Mfr. and Designation	Drawing or Specification No.
33-1	3D9050-51	CAPACITOR: fixed; 50 mmfd, $\pm 5\%$; 500 volts d-c working; silver mica; low loss molded bakelite case; dimensions $1\frac{1}{16}$ " x $\frac{7}{16}$ " x $\frac{3}{16}$ "; axial leads	Antenna unit padder	Cornell-Dubilier type 5RS Aerovox 1469	Stromberg-Carlson
33-2		CAPACITOR: same as 33-1	2nd R-F padder		
33-3		CAPACITOR: same as 33-1	1st detector padder		
36	3D9027-1 (also shipped as 3DF8018)	CAPACITOR: fixed; 27 mmfd, $\pm 2.5\%$; 500 volts d-c working; ceramic; insulated; axial leads; dimensions $\frac{7}{16}$ " long; $\frac{7}{32}$ " diameter	Oscillator temperature compensating	Erie Resistor type N750K	Stromberg-Carlson D-4055
56	3Z6610-59	RESISTOR: fixed; 10,000 ohms, $\pm 10\%$; 1 watt; carbon insulated; dimensions $\frac{9}{16}$ " long x $\frac{1}{32}$ " diameter; axial leads	Bleeder	Allen-Bradley Co. type GB	Stromberg-Carlson P-30417
57	3Z6627-8	RESISTOR: fixed; 27,000 ohms, $\pm 10\%$; 1 watt; carbon insulated; dimensions $\frac{9}{16}$ " x $\frac{7}{32}$ " diameter; axial leads	Voltage regulator series resistor	Allen-Bradley Co. type GB	Stromberg-Carlson P-34578
64	3D9035-3	CAPACITOR: fixed; 35 mmfd, $\pm 2.5\%$; 500 volts d-c working; silver mica; low loss molded bakelite case; dimensions $1\frac{1}{16}$ " x $\frac{7}{16}$ " x $\frac{3}{16}$ "; axial leads	Oscillator unit padder	Cornell-Dubilier type 5R	Stromberg-Carlson D-4380
101-A	2C4348M/T2	TRANSFORMER AUDIO ASSEMBLY: primary 3000 turns #38 enameled wire; primary impedance 4300 ohms at 60 cps a.c. 0.018 amps d.c.; secondary 1090 turns #38 enameled wire; core size $\frac{5}{8}$ " x $\frac{7}{8}$ "; turn ratio $2\frac{3}{4}$ to 1; secondary 4000 ohms; tapped at 300 ohms; reactor; 2500 turns #35 enameled wire; $\frac{5}{8}$ " x 1" core; d-c resistance 300 ohms; impedance at 60 cps a.c. with 65 mils d.c.; 2250 ohms min.; 0.015 mfd; solder lugs on side; all terminals marked; diagram on top; hermetically sealed steel case; overall dimensions 4" high, $1\frac{13}{16}$ " wide x 3" front to back, mounting centers $1\frac{1}{2}$ " x $1\frac{1}{16}$ ".	Output	Chicago Transformer Co. special Standard Transformer Co. special Acme Electric Co. special	Stromberg-Carlson D-3560
101-B		TRANSFORMER AUDIO ASSEMBLY: same as 101-A	Filter		
101-C		TRANSFORMER AUDIO ASSEMBLY: same as 101-A	C-W oscillator time constant		
106	3Z9858-1	SWITCH: toggle; DPST, 3 amps; 125 volts d.c.; 1 amp, 250 volts d.c.; silver-plated contacts and terminals, 2 at top and 2 at bottom; $2\frac{1}{32}$ " deep, $1\frac{3}{4}$ " high (including terminals), $1\frac{1}{16}$ " thick; $1\frac{5}{32}$ "-32 thread bushing $\frac{1}{4}$ " long	C-W oscillator (OFF-ON)	Arrow Hart & Hege- man Co. 81009	Stromberg-Carlson D-3734

TABLE OF REPLACEABLE PARTS — PART II

MODEL: RADIO RECEIVERS BC-348-E, BC-348-M, BC-348-P ONLY

Reference Symbol	Army Stock Number Navy Type Number British Reference Number	Name of Part and Description	Function	Mfr. and Designation	Drawing or Specification No.
108	3Z9693-2	SWITCH ASSEMBLY: rotary; 2-section; 6-position; 2-wafer, laminated bakelite wafers; contacts and terminals silver-plated; shorting type dimensions (over-all) length $1\frac{13}{16}$ " , height $1\frac{23}{32}$ " , width $1\frac{35}{64}$ " , mounting centers 1.562"	Band switch antenna unit	P. R. Mallory RO-216136	Stromberg-Carlson D-3489
109		SWITCH ASSEMBLY: same as 108	Band switch antenna unit		
110		SWITCH ASSEMBLY: same as 108	Band switch r-f unit		
111		SWITCH ASSEMBLY: same as 108	Band switch r-f unit		
112		SWITCH ASSEMBLY: same as 108	Band switch detector unit		
113		SWITCH ASSEMBLY: same as 108	Band switch detector unit		
114	3Z9693-1	SWITCH ASSEMBLY: rotary; 4 sections; 6 positions; 4 wafers, laminated bakelite wafers; terminals and contacts nickel-plated; shorting type; dimensions $1\frac{3}{4}$ " long, $1\frac{23}{32}$ " high, $1\frac{35}{64}$ " wide; mounting centers 1.562"	Band switch oscillator unit	P. R. Mallory Co. RO-216110 Oak Mfg. Co.	Stromberg-Carlson D-3519
115		SWITCH ASSEMBLY: same as 114	Band switch oscillator unit		
116		SWITCH ASSEMBLY: same as 114	Band switch oscillator unit		
117		SWITCH ASSEMBLY: same as 114	Band switch oscillator unit		
251	2C4348M/T3	TRANSFORMER ASSEMBLY: i-f; 915 kc; permeability-tuned; primary winding Q is equal to $101 \pm 20\%$, 1500 kc; inductance equals 79 microhenries $\pm 3\%$; resistance equals 1.99 ohms $\pm 18\%$; includes 2 mica capacitors 500 microfarads; 500 volts; 1 mica capacitor 250 microfarads; 500 volts; assembled in a shield can; 4 soldering lugs brought out at bottom; 1 terminal on top; dimensions 4 " high x $1\frac{1}{16}$ " x $1\frac{1}{16}$ " ; $1\frac{3}{8}$ " between centers; 2 spade bolt mountings	1st I-F transformer	F. W. Sickles special	Stromberg-Carlson D-3749
252	2C4348M/T4	TRANSFORMER ASSEMBLY: i-f; 915 kc; permeability-tuned; primary winding Q is equal to $101 \pm 20\%$, 1500 kc; inductance equals 69 microhenries $\pm 3\%$; resistance equals 1.9 ohms $\pm 20\%$; secondary winding resistance start to top 0.95 ohms $\pm 20\%$; includes 2 mica capaci-	Second i-f transformer	F. W. Sickles special	Stromberg-Carlson D-3750

TABLE OF REPLACEABLE PARTS — PART II

MODEL: RADIO RECEIVERS BC-348-E, BC-348-M, BC-348-P ONLY

Reference Symbol	Army Stock Number Navy Type Number British Reference Number	Name of Part and Description	Function	Mfr. and Designation	Drawing or Specification No.
253	2C4348M/T5	<p>tors 260 mmfd; 500 volts assembled in a shield can; 4 soldering lugs brought out at bottom; 1 on top; dimensions 4" high x 1 7/16" square; 2 spade bolt mountings</p> <p>TRANSFORMER ASSEMBLY: i-f; 915 kc; permeability-tuned; primary winding resistance 1.9 ohms $\pm 20\%$; resistance start to top 0.95 ohms $\pm 20\%$; secondary winding Q equals 101 $\pm 20\%$; 1500 kc; inductance equals 69 microhenries $\pm 3\%$; includes 1 mica capacitor 260 microfarads; 500 volts; 1 mica capacitor 250 microfarads; 500 volts, assembled in a shield can, 3 soldering lugs brought out at bottom, 1 on top; 2 spade bolt mountings; dimensions 4" high x 1 7/16" square; mounting centers 1 3/8"</p>	3rd I-F transformer	F. W. Sickles special	Stromberg-Carlson D-3751
254	2C4348M/T6	<p>TRANSFORMER ASSEMBLY: i-f; 915 kc; permeability-tuned; primary winding Q is equal to 102 $\pm 20\%$, 1500 kc; inductance equals 122 microhenries $\pm 3\%$; resistance equals 2.6 ohms $\pm 20\%$; secondary winding Q equals 126 $\pm 20\%$, 700 kc; inductance equals 340 microhenries $\pm 3\%$; resistance 4.5 ohms $\pm 18\%$; includes 1 mica capacitor 150 microfarads; 500 volts; 1 mica capacitor 47 microfarads; 500 volts; assembled in a shield can; 4 soldering lugs brought out at bottom; 2 spade bolt mountings; dimensions 4" high x 1 7/16" square; mounting centers 1 3/8"</p>	4th I-F transformer	F. W. Sickles special	Stromberg-Carlson D-3752
255	2C4348M/F1	<p>CRYSTAL FILTER UNIT: 915 kc; consists of 1 variable capacitor, 1 fixed mica capacitor, 1 transformer, 1 SPST switch, 1 crystal assembly mounted in holder; permeability-tuned; 2 solder terminals on top; 1 solder terminal on bottom; can dimensions 4" high (including cap) 1 7/16" x 1 7/16"; mounting centers 1 3/8" includes RCA type M18658A crystal and holder</p>	I-F selectivity	F. W. Sickles special	Stromberg-Carlson D-3814
256	2C4348M/PS	<p>OSCILLATOR UNIT: c-w assembly; beat frequency; consists of 1 variable capacitor; 1 fixed paper capacitor; 3 fixed mica capacitors; 1 fixed resistor; 1 c-w oscillator transformer; assembled in an aluminum can; 3 terminals at bottom; dimensions 4" high x 1 7/16"; square mounting 1 3/8"; permeability-tuned from top; c-w control on bottom; mounting dimensions 1 3/8"</p>	C-W reception	F. W. Sickles special	Stromberg-Carlson D-3791

TABLE OF REPLACEABLE PARTS — PART II

MODEL: RADIO RECEIVERS BC-348-E, BC-348-M, BC-348-P ONLY

Reference Symbol	Army Stock Number Navy Type Number British Reference Number	Name of Part and Description	Function	Mfr. and Designation	Drawing or Specification No.
257	2C4348M/A11	ANTENNA UNIT ASSEMBLY: complete with shield can; can includes 3 variable capacitors, 50 micro-microfarad max; 2 variable capacitors, 25 micro-microfarad max; 1 fixed paper capacitor, 0.01 microfarad; 4 fixed mica capacitors; 1 fixed carbon resistor 1/2 watt; 100,000 ohms; 1 inductance coil, antenna band 1; 1 inductance coil, antenna band 2; 1 inductance coil, antenna band 3; 1 inductance coil, antenna band 4; 1 inductance coil, antenna band 5; 1 inductance coil, antenna band 6; 1 switch, 6-position, 1-wafer; 2 sections; dimensions 7 3/8" x 4 3/4" x 2"; special bracket on side for mounting; mounting dimensions 5.312" x 1.25"; trimmers on end and top	Antenna to 1st R-F tube coupling	Stromberg-Carlson D-3411	Stromberg-Carlson D-3411
258	2C4348M/F13	R-F UNIT ASSEMBLY: aluminum shield can; can includes 2 air trimmer, 50 micro-microfarad max (variable capacitors), 1 air trimmer, 25 micro-microfarad max; 1 fixed paper capacitor 0.01 microfarad; 1 fixed mica capacitor 155 micro-microfarad; 1 fixed mica capacitor 135 micro-microfarad; 1 fixed mica capacitor 460 micro-microfarad; 1 fixed mica capacitor 75 micro-microfarad; 1 fixed resistor 1/2 watt, 4700 ohms; 1 fixed resistor 1/2 watt, 100,000 ohms; 1 r-f transformer, band 1; 1 r-f transformer band 2; 1 r-f transformer, band 3; 1 r-f transformer, band 4; 1 r-f transformer, band 5; 1 r-f transformer, band 6; 2 rotary switches, 6-position; 2 wafers; dimensions 7 3/8" x 4 3/4" x 2"; 2 brackets on side for mounting; 5.312" x 1/25" mounting dimensions	1st R-F to 2nd R-F tube coupling	Stromberg-Carlson special	Stromberg-Carlson D-3413
259	2C4348M/D12	DETECTOR UNIT ASSEMBLY: complete with shield can; can includes 2 capacitors, air trimmers, 50 micro-microfarads max; 2 capacitors, air trimmers, 25 micro-microfarads max; 1 paper capacitor, 0.01 microfarad; 5 mica capacitors; 1 resistor, 1/2 watt, 4700 ohms; 1 transformer 1st detector, band 1; 1 transformer 1st detector, band 2; 1 transformer 1st detector, band 3; 1 transformer 1st detector, band 4; 1 transformer 1st detector, band 5; 1 transformer 1st detector, band 6; 1 switch, 6 positions, 1 wafer, 2-section; dimensions 7 3/8" x 4 3/4" x 2". Mounting dimensions 5.312" x 1.25"; special bracket mounting; trimmers tuned at end and top	2nd R-F to 1st detector tube coupling	Stromberg-Carlson D-3411	Stromberg-Carlson D-3411

TABLE OF REPLACEABLE PARTS — PART II

MODEL: RADIO RECEIVERS BC-348-E, BC-348-M, BC-348-P ONLY

Reference Symbol	Army Stock Number Navy Type Number British Reference Number	Name of Part and Description	Function	Mfr. and Designation	Drawing or Specification No.
260	2C4348M/P6	OSCILLATOR UNIT ASSEMBLY: complete with shield can; includes: 2 variable capacitors 50 micromicrofarad max; 4 variable capacitors, 25 micromicrofarad max; 2 fixed paper capacitors 0.01 microfarad; 7 fixed mica capacitors; 4 ceramic capacitors; 3 resistors; 1 oscillator transformer band 1; 1 oscillator transformer band 2; 1 oscillator transformer band 3; 1 oscillator transformer band 4; 1 oscillator transformer band 5; 1 oscillator transformer band 6; 1 switch assembly, 4 sections; 6 positions; 1 cover plate with screws; 1 tube socket, octal, VT-65; dimensions $7\frac{3}{8}$ " x $2\frac{1}{2}$ " x $5\frac{1}{4}$ "; side bracket mounting; mounting dimensions 5 " x 0.812 " x 1.25 "	Heterodyne oscillator to 1st detector coupling	Stromberg-Carlson D-3414	Stromberg-Carlson D-3414
301	3C370-2 (also shipped as 2C4224B/8, 2C4348M/C1, 2C4348H/C1 and 3H1628E/C2)	COIL: r-f choke; 75 turns; #15 AWG enameled; layer wound; wound on maple or birch form measuring $\frac{3}{4}$ " long by $\frac{1}{2}$ " diam; inductance 83 microhenries; d-c resistance 0.006 ohms; $\pm 5\%$ — 10% ; overall dimensions $\frac{3}{4}$ " length x $1\frac{1}{16}$ " diam; mounts by a $\frac{1}{4}$ " bolt threaded into end of coil form; solder lug terminal at each end of coil form	R-F choke for dynamotor	RCA M-66347-501	RCA M-66347-501
302	3C370-1 (also shipped as 2C4348M/C2, 2C4348H/C2, 2C4224B/7 and 3H1628E/C1)	COIL: r-f choke; wood core $\frac{1}{2}$ " diameter x $\frac{5}{8}$ " long; 300 turns #30 single silk enameled wire; universal winding $\frac{3}{16}$ " thick; d-c resistance 85.5 ohms ± 5 ohms; terminal board with 3 terminals $1\frac{3}{8}$ " x $1\frac{3}{8}$ " x $1\frac{1}{16}$ " mounting screw through core	Filter for dynamotor	Stromberg-Carlson D-3909	Stromberg-Carlson D-3909
500	3Z7200-4 (also shipped as 2C4348H/R2 and 2C4348M/R2)	RESISTOR ASSEMBLY: variable; wire wound (rheostat) 200 ohms, $\pm 10\%$; 4 watts; 2 solder terminals; $\frac{3}{4}$ " deep x $1\frac{5}{8}$ " maximum diameter; shaft $\frac{1}{4}$ " diameter $\frac{5}{8}$ " long; $\frac{3}{8}$ "-32 thread bushing $\frac{3}{32}$ " long; shaft $\frac{3}{32}$ " flat x $\frac{9}{32}$ " long	Dial light control	P. R. Mallory special D-113683 Chicago Tel. Co. type 25	Stromberg-Carlson D-3880
501-A	3Z5993-2	RESISTOR: fixed; tapped; 3 ohms; 1.5 watts, $\pm 10\%$; 190 ohms; 1.9 watts, $\pm 10\%$; bakelite insulated; metal case; overall length $3\frac{1}{16}$ "; $1\frac{1}{16}$ " wide x $\frac{5}{16}$ " high; mounting centers $2\frac{1}{2}$ "; 3 solder lug terminals on top	Filament	International Resistor Co. type MN-2	Stromberg-Carlson D-3937
501-B		RESISTOR: same as 501-A			

TABLE OF REPLACEABLE PARTS — PART II

MODEL: RADIO RECEIVERS BC-348-E, BC-348-M, BC-348-P ONLY

Reference Symbol	Army Stock Number Navy Type Number British Reference Number	Name of Part and Description	Function	Mfr. and Designation	Drawing or Specification No.
502	3Z1935	FUSE FU-35: 5 amps, 25 volts; cartridge; dimensions 1 $\frac{1}{4}$ " long x 1 $\frac{1}{64}$ " diameter	Primary power fuse	Littelfuse Lab. type 1094	Stromberg-Carlson D-3886
503	3Z6006-3 (also shipped as 3Z6006-5)	RESISTOR: fixed; wire wound; 60 ohms; 3.7 watts, $\pm 10\%$; bakelite insulation; metal case; overall length 3 $\frac{3}{16}$ ", overall height $\frac{5}{16}$ " (excluding terminals), 1 $\frac{1}{16}$ " wide; mounting centers 2 $\frac{1}{2}$ "; 2 soldering lug terminals on top	Dial lamp series	International Resistor Co. type MW-2	Stromberg-Carlson D-3888
504	3Z2909 (also shipped as 2C4348H/C5 and 2C4348M/F2 and 3Z2910)	FUSE CLIP ASSEMBLY: laminated phenolic strip with fuse clips; 2 phosphor bronze fuse clips nickel-plated; overall length 2 $\frac{3}{8}$ " x $\frac{1}{2}$ " wide x $\frac{3}{32}$ " thick; fuse clips $\frac{5}{16}$ " x $\frac{1}{16}$ " x $\frac{3}{16}$ "; solder lug terminals	Fuse holder	American Radio Hardware special	Stromberg-Carlson D-3881
511	3H1628H/A1 (also shipped as 3H1628M/A1)	ARMATURE: dynamotor; complete with two bearings; commutator bars; dimensions 5" long; shaft 0.250" diameter each end; commutator diameter 0.966"	Armature for Dynamotor DM-28-(*)	Eicor Inc. Webster-Chicago Corp. type 5-1046A	Stromberg-Carlson D-5584
512	3H1624F/B5 (also shipped as 3H1624B/3.1 and 3H1624B/3)	BRUSH: carbon, low voltage positive; consists of phosphor bronze springs, carbon brush, pigtail lead and contact; dimensions 2 $\frac{3}{32}$ " long, $\frac{5}{16}$ " wide, 0.187" thick; overall length 1 $\frac{15}{16}$ "	Brush for dynamotor	Pure Carbon part #309-L Becker Bros. part #M-60	Stromberg-Carlson D-4350
513	3H1624F/B6 (also shipped as 3H1624B/3.1 and 3H1624B/3)	BRUSH: carbon, low voltage negative; consists of phosphor bronze spring, carbon brush, pigtail lead and contact; dimensions 2 $\frac{3}{32}$ " long, $\frac{5}{16}$ " wide, 0.187" thick; overall length 1 $\frac{15}{16}$ "	Brush for dynamotor	Pure Carbon part #309-L Becker Bros. part #M-60	Stromberg-Carlson D-4351
VT-86	2J6K7 (2T86)§	VACUUM TUBE: JAN-6K7	1st R-F amplifier		
VT-86	2J6K7 (2T86)§	VACUUM TUBE: JAN-6K7	2nd R-F amplifier		
VT-91	2J6J7 (2T91)§	VACUUM TUBE: JAN-6J7	1st detector		
VT-65	2J6C5 (2T65)§	VACUUM TUBE: JAN-6C5	Oscillator		
VT-86	2JK7 (2T86)§	VACUUM TUBE: JAN-6K7	1st I-F amplifier		
VT-70	2J6F7 (2T70)§	VACUUM TUBE: JAN-6F7	C-W oscillator and 2nd I-F		
VT-93	2J6B8 (2T93)§	VACUUM TUBE: JAN-6B8	3rd I-F and 2nd detector		
VT-48	2J41 (2T48)§	VACUUM TUBE: JAN-41	Audio output amplifier		

§ Tubes having these stock numbers are built to VT-() specifications and may be substituted for the above.

LIST OF MANUFACTURERS

<i>Symbol</i>	<i>Name of Manufacturer</i>
AEM	Acme Electric and Mfg. Co.
A	Aerovox Corp.
AP	Alden Products Co.
AB	Allen-Bradley Co.
AG	Aluminum Goods Mfg. Co.
ARH	American Radio Hardware
AHH	Arrow-Hart & Hegeman Co.
AW	Automatic Winding Co.
ADC	A. D. Cardwell Mfg. Co.
BD	Black and Decker
CRL	Central Radio Laboratory
CT	Chicago Transformer
CTS	Chicago Telephone Supply Co.
CM	Cinch Manufacturing Corp.
CH	H. Cole & F. C. Hersee Co.
CD	Cornell-Dubilier Corp.
CN	Crowe Name Plate & Mfg. Co.
DMD	Dahlstrom Metallic Door Co.
DDC	Doehler Diecasting Co.
E	Eicor, Inc.
ECE	Electro-Chemical Engraving Co.
EMC	Electro-Motive Mfg. Co.
ER	Erie Resistor Corp.
EG	Edwin I. Guthman & Co., Inc.
GE	General Electric Co.
HM	Hammarlund Manufacturing Co.
HPS	Hunter Pressed Steel
IRC	International Resistance Co.
LC	Lovejoy Chaplet Co.
LL	Littelfuse Laboratories
PRM	P. R. Mallory & Co.
MR	Micamold Radio Corp.
NL	National Lock Co.
OM	Oak Manufacturing Co.
OVC	Oneida Vault & Casket Co.
QCG	Quaker City Gear Co.
RC	Radio Condenser Co.
RMC	Rochester Mfg. Co.
RE	Russell Electric Co.
SG	Sargent & Greenleaf Inc.
FWS	F. W. Sickles Co.
SMC	Solar Manufacturing Co.
SS	Sprague Specialties Co.
ST	Standard Transformer Corp.
WC	Webster-Chicago Corp.
WE	Westinghouse Electric & Manufacturing Co.
W	Wincharge Corp.
SSW	S. S. White Dental Co.

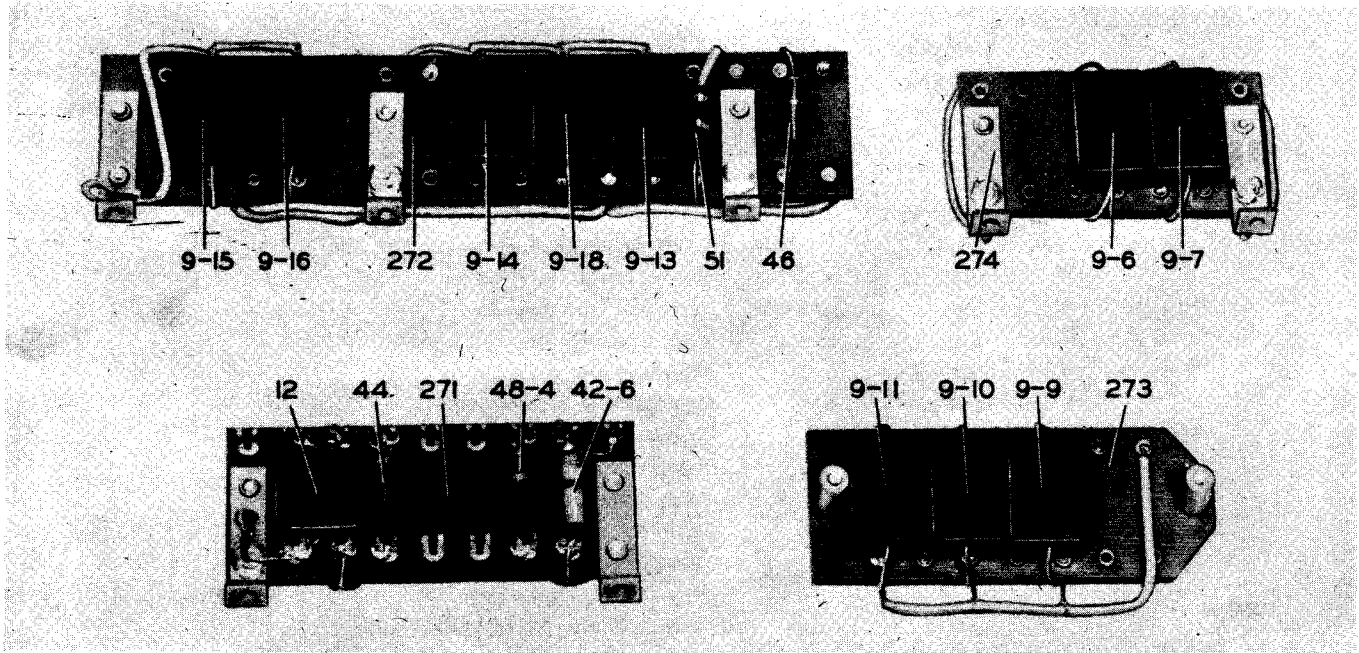

Figure 23 — Radio Receiver BC-348-(*) or BC-224-(*), Resistor Boards, View A

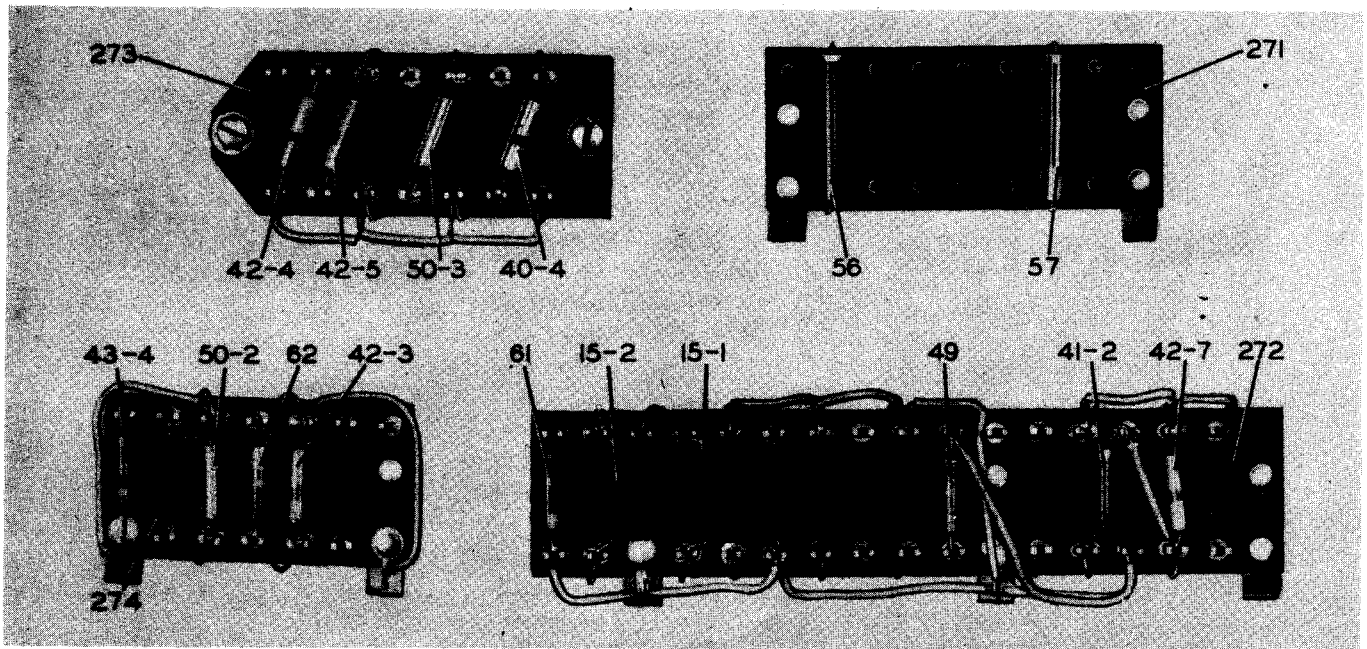

Figure 24 — Radio Receiver BC-348-(*) or BC-224-(*), Resistor Boards, View B

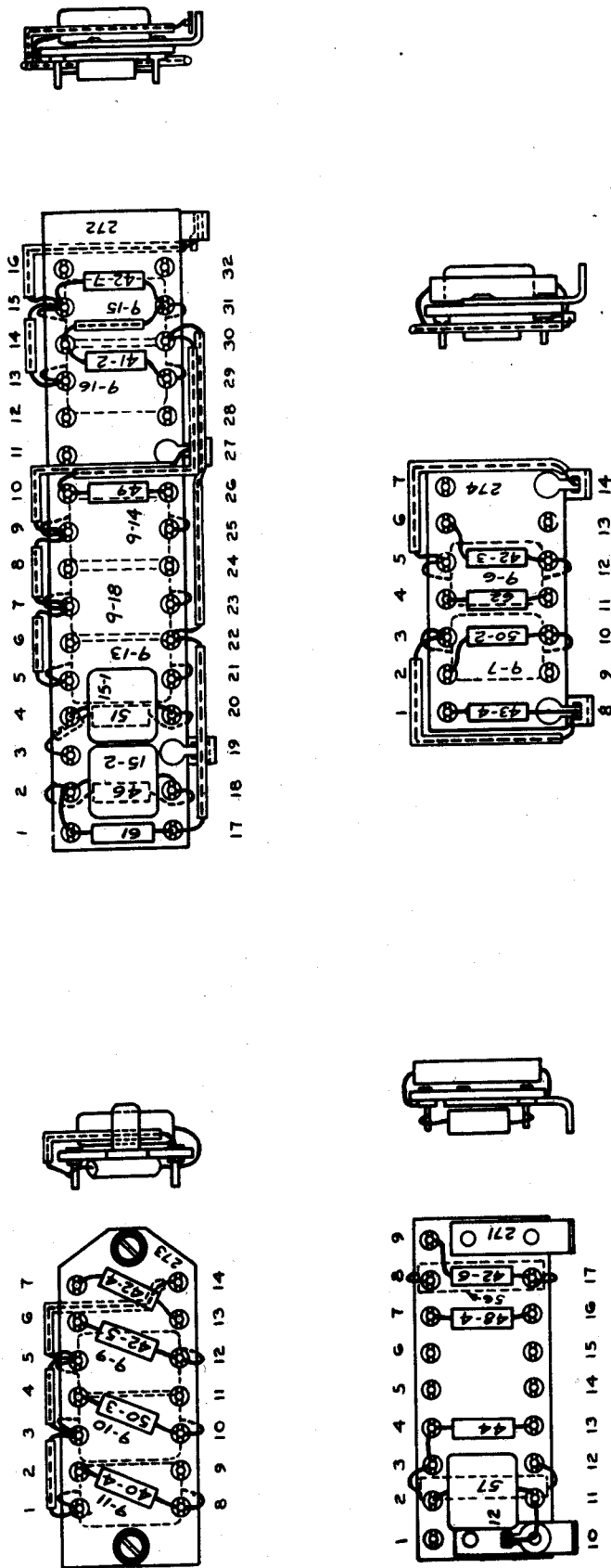

Figure 25 — Radio Receiver BC-348-(*) or BC-224-(*)
Resistor Boards Wiring Diagram

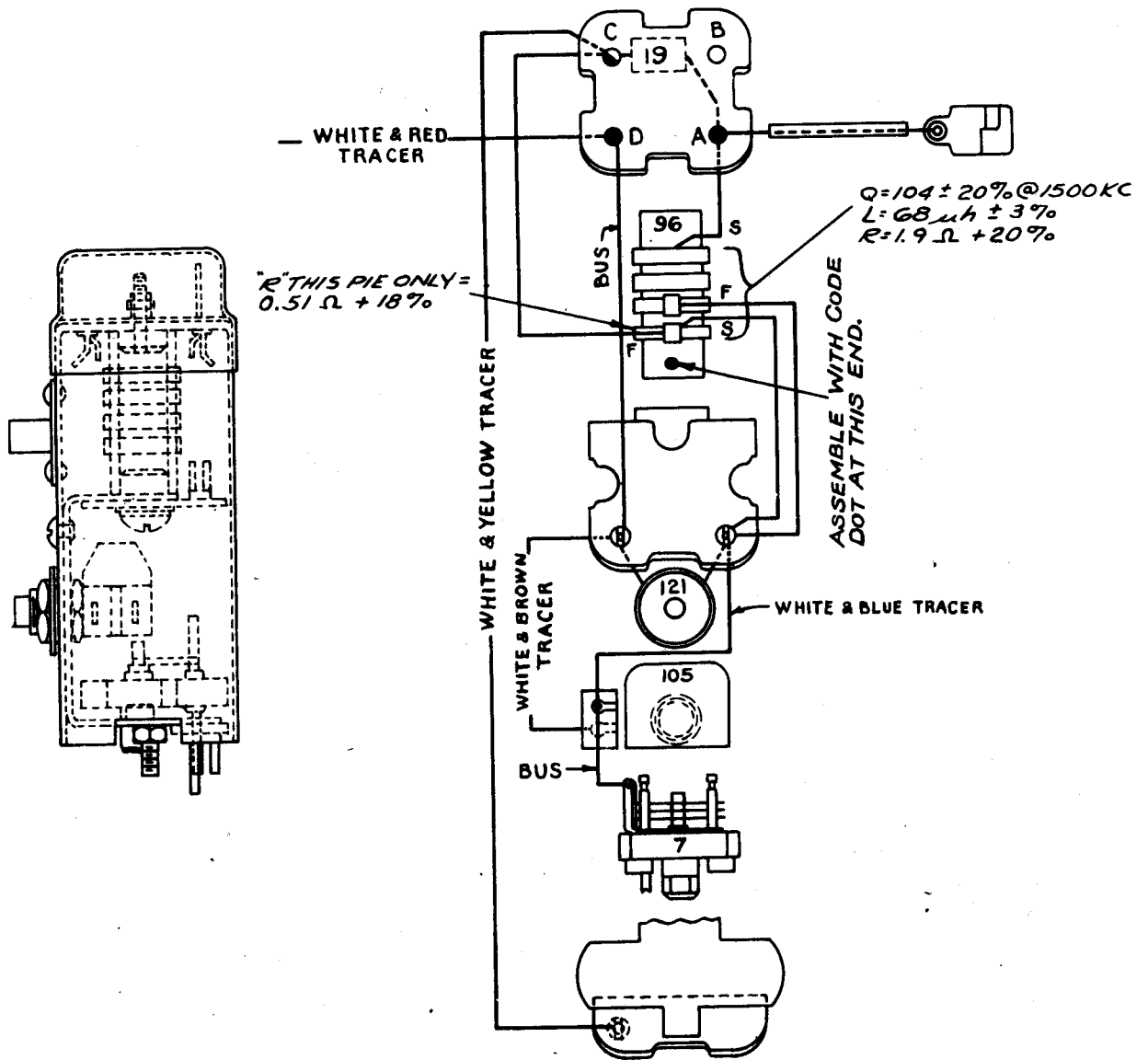

Figure 27 — Wiring Diagram, Crystal Filter

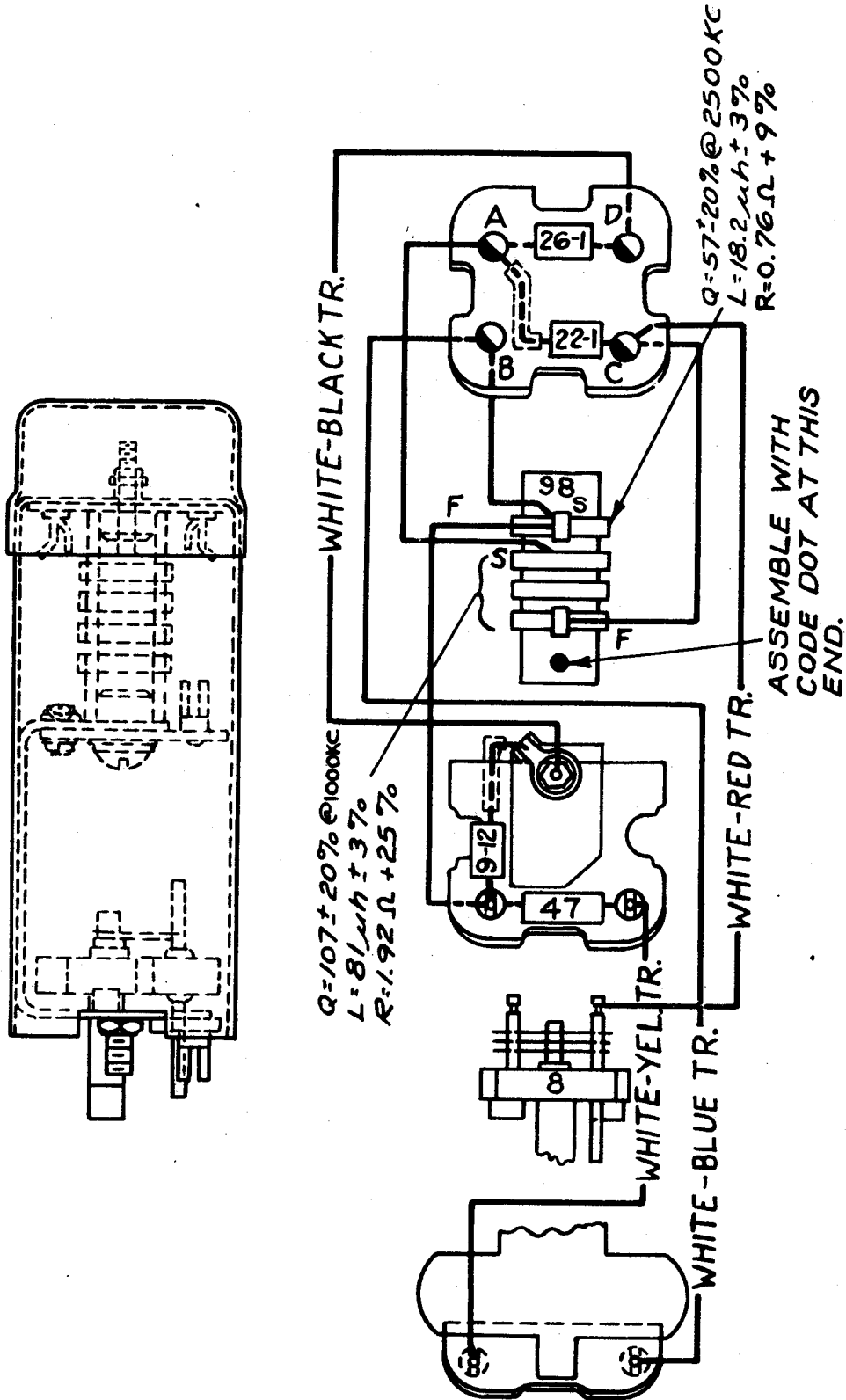

Figure 28 — Wiring Diagram, Beat Frequency Oscillator

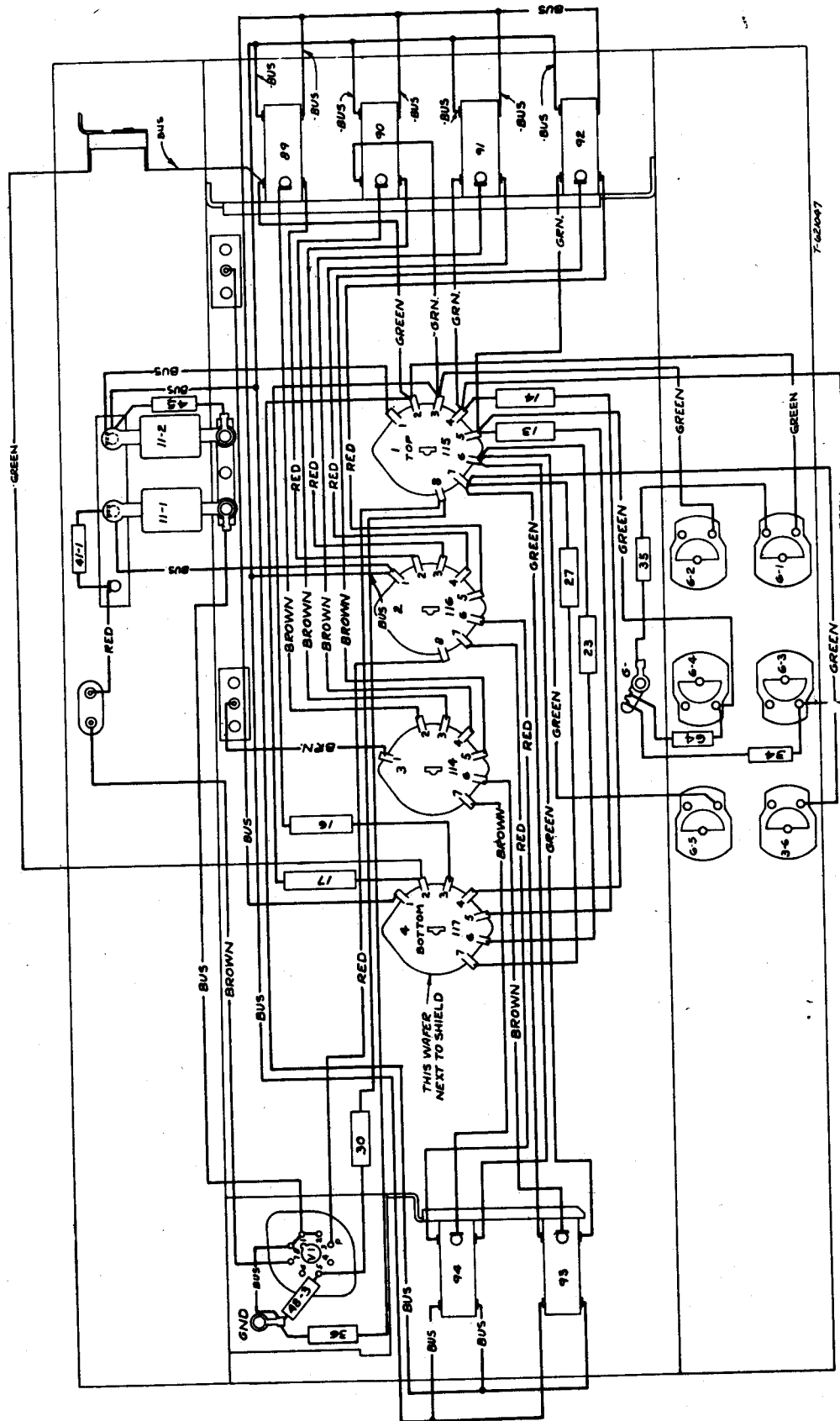

Figure 29 — Wiring Diagram, Oscillator Unit

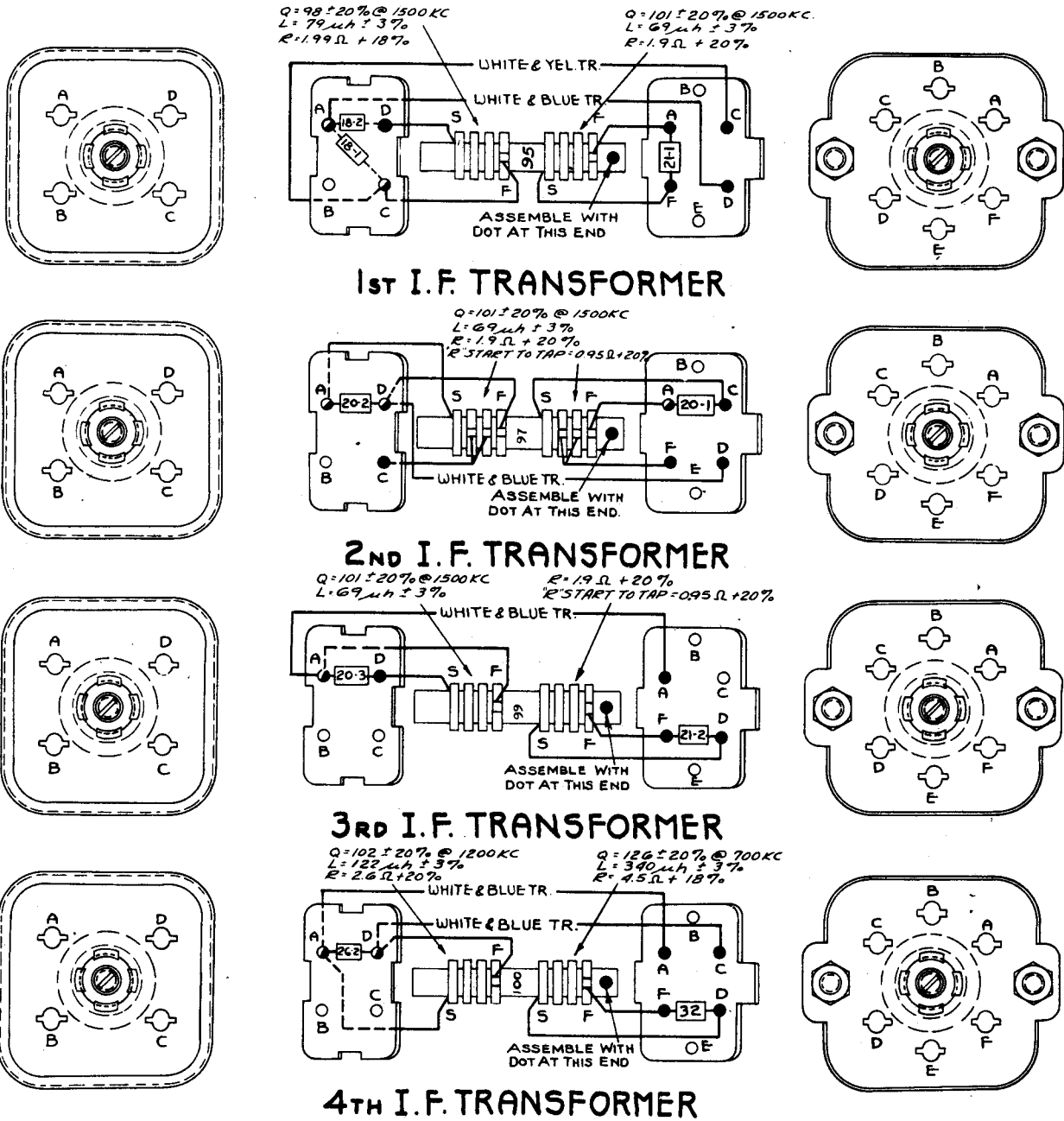

Figure 30 — Wiring Diagram, I-F Transformer

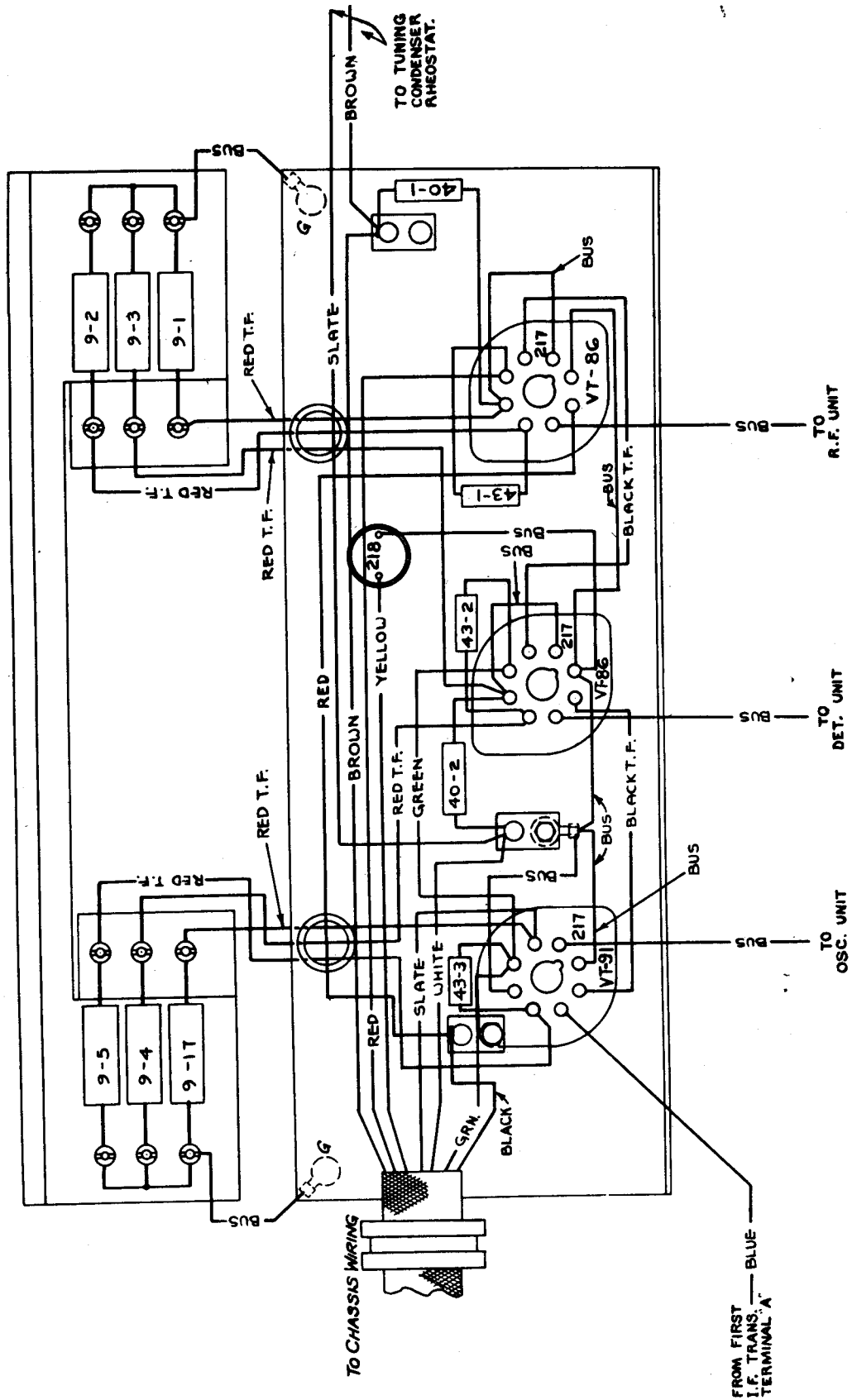

Figure 31 — Radio Receiver BC-348-(*) , Wiring Diagram, Tube Shelf

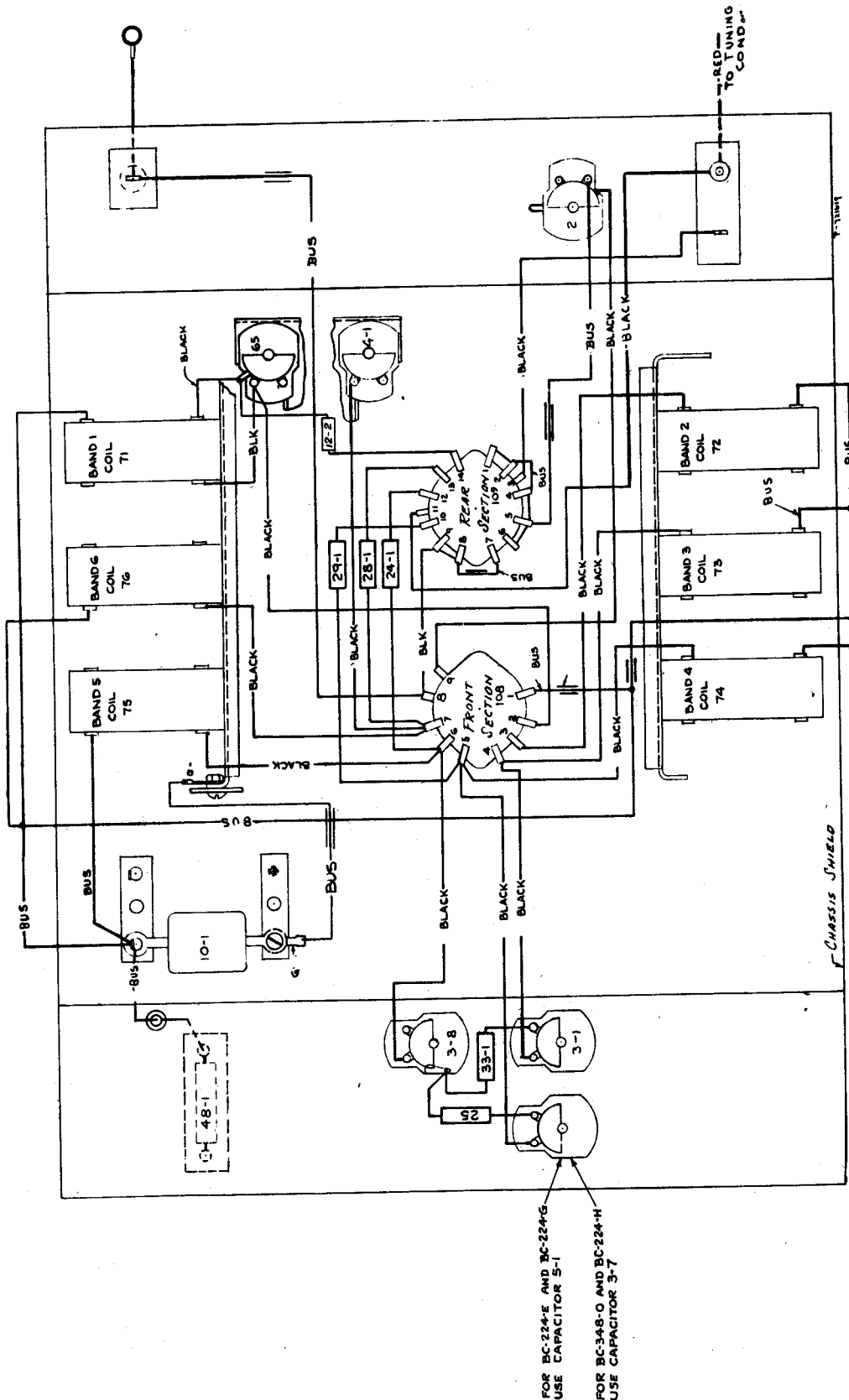

Figure 33 — Wiring Diagram, Antenna Unit

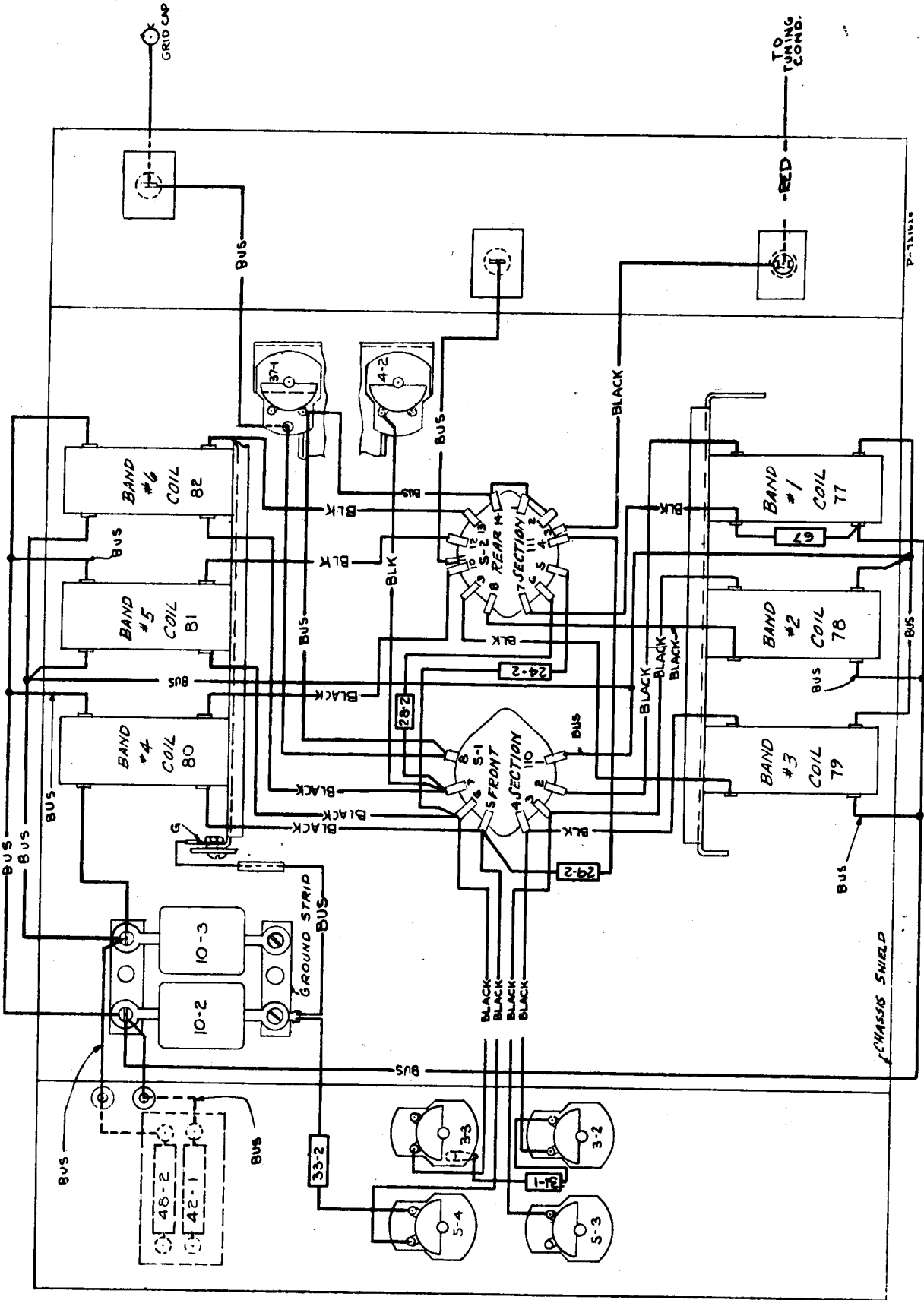

Figure 34 — Wiring Diagram, R-F Unit

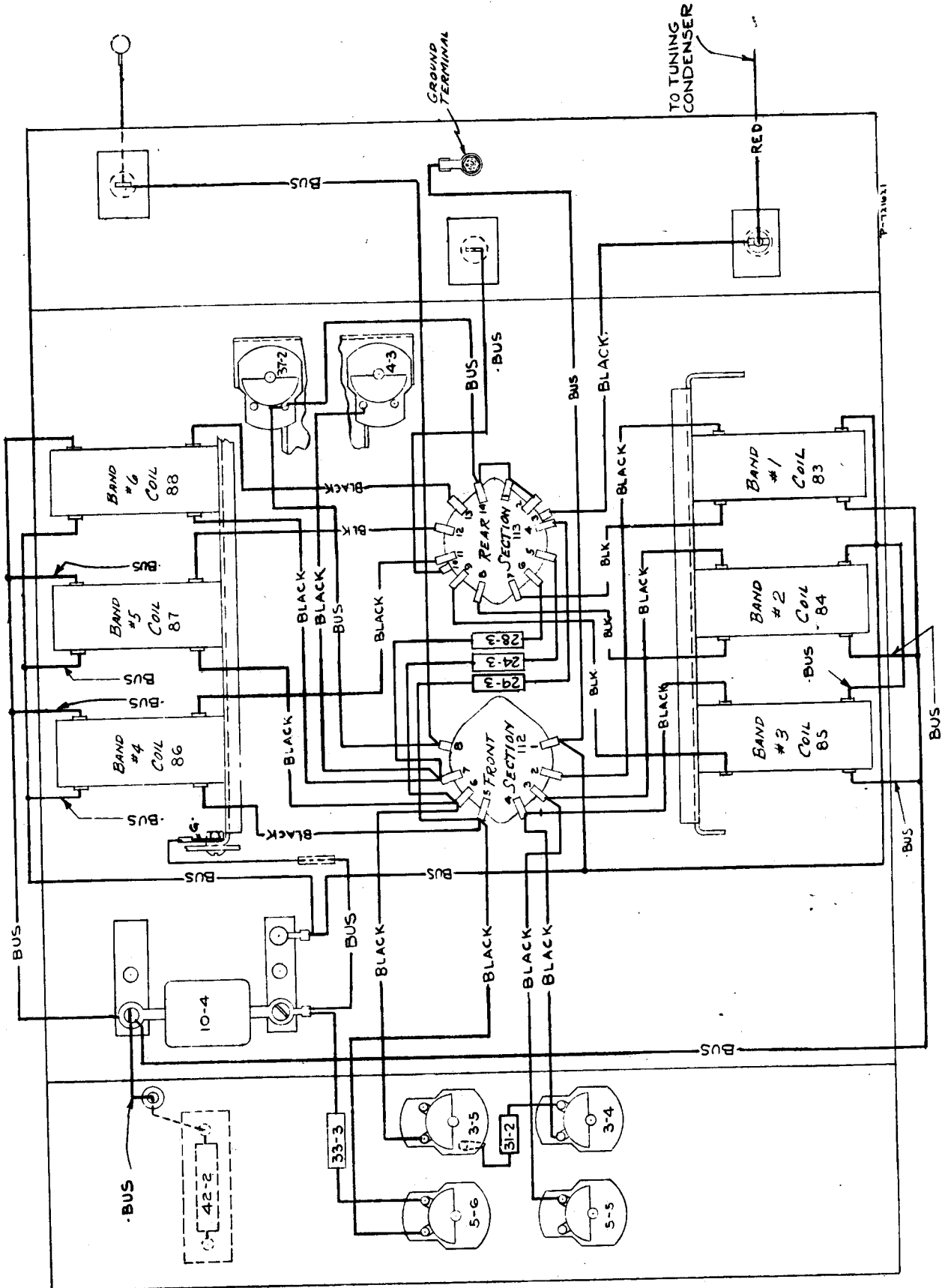
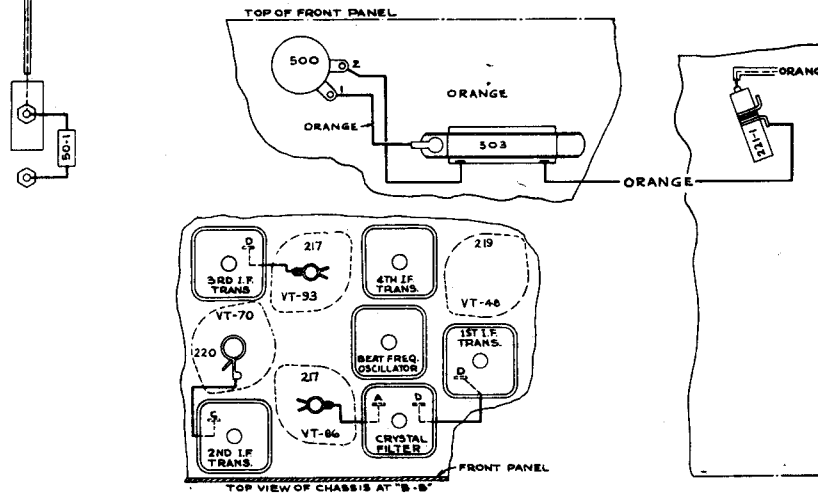
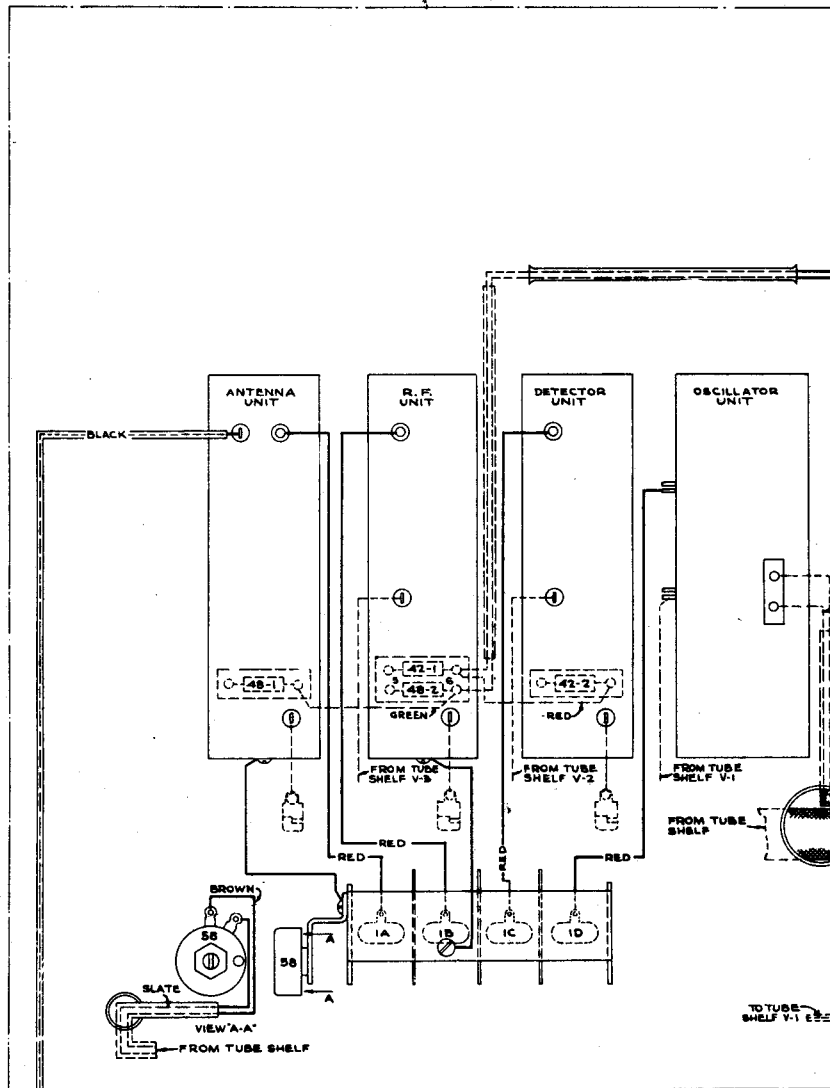

Figure 35 — Wiring Diagram, Detector Unit



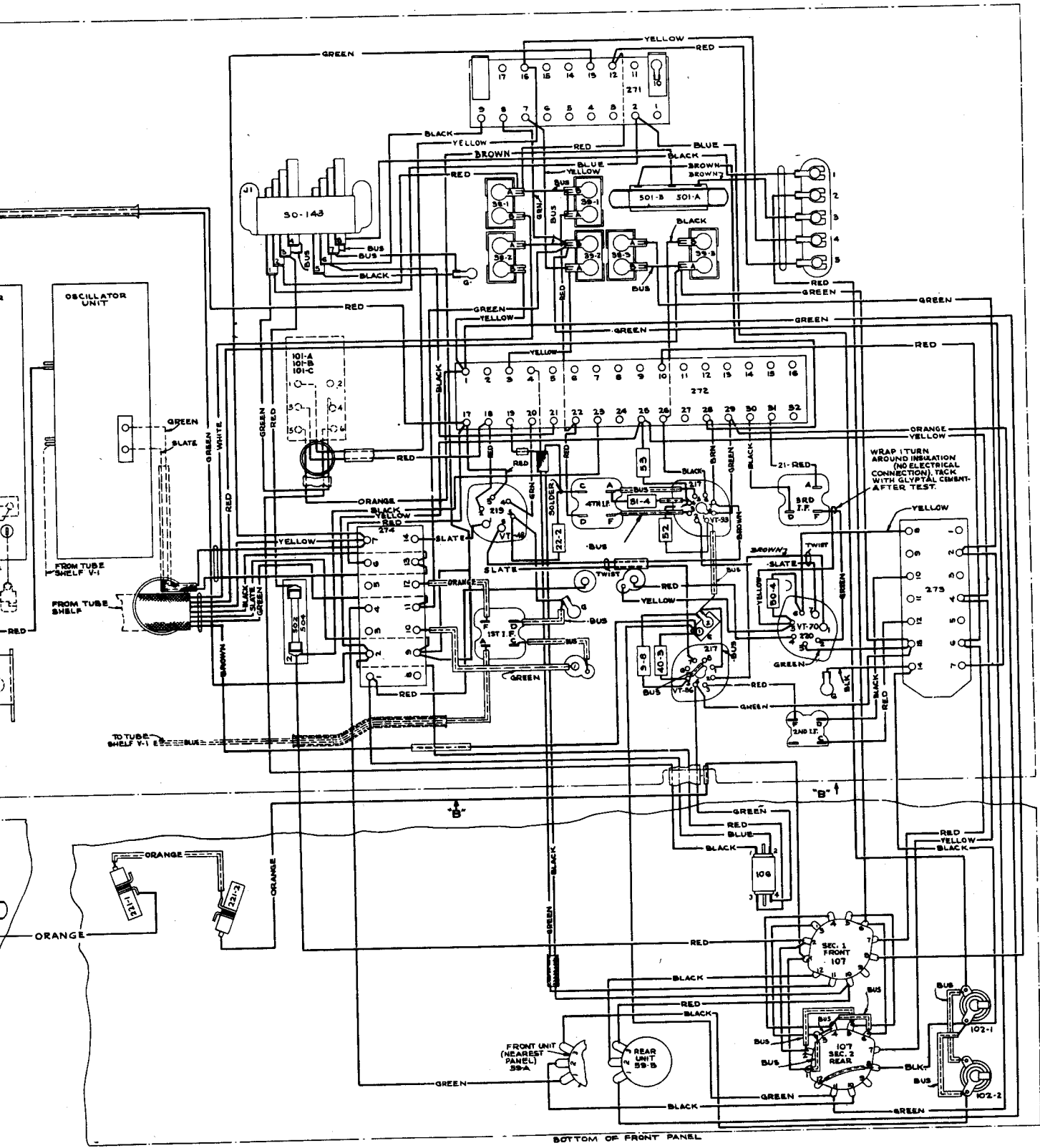
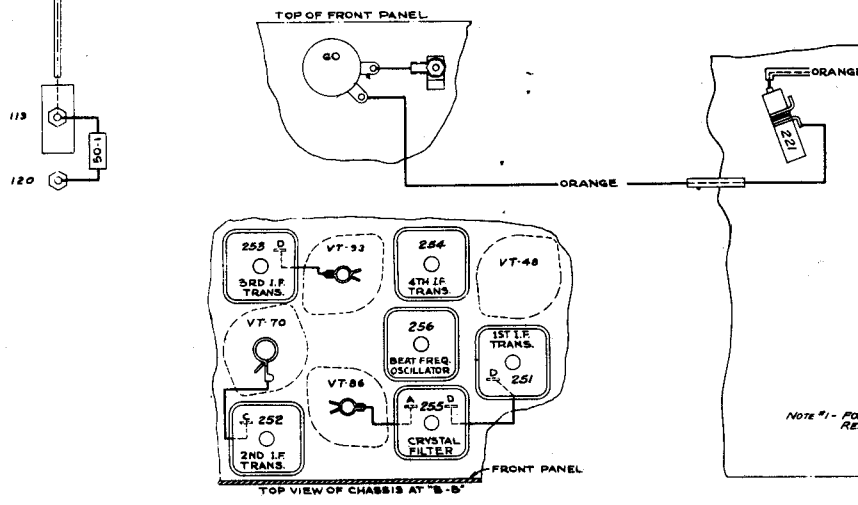
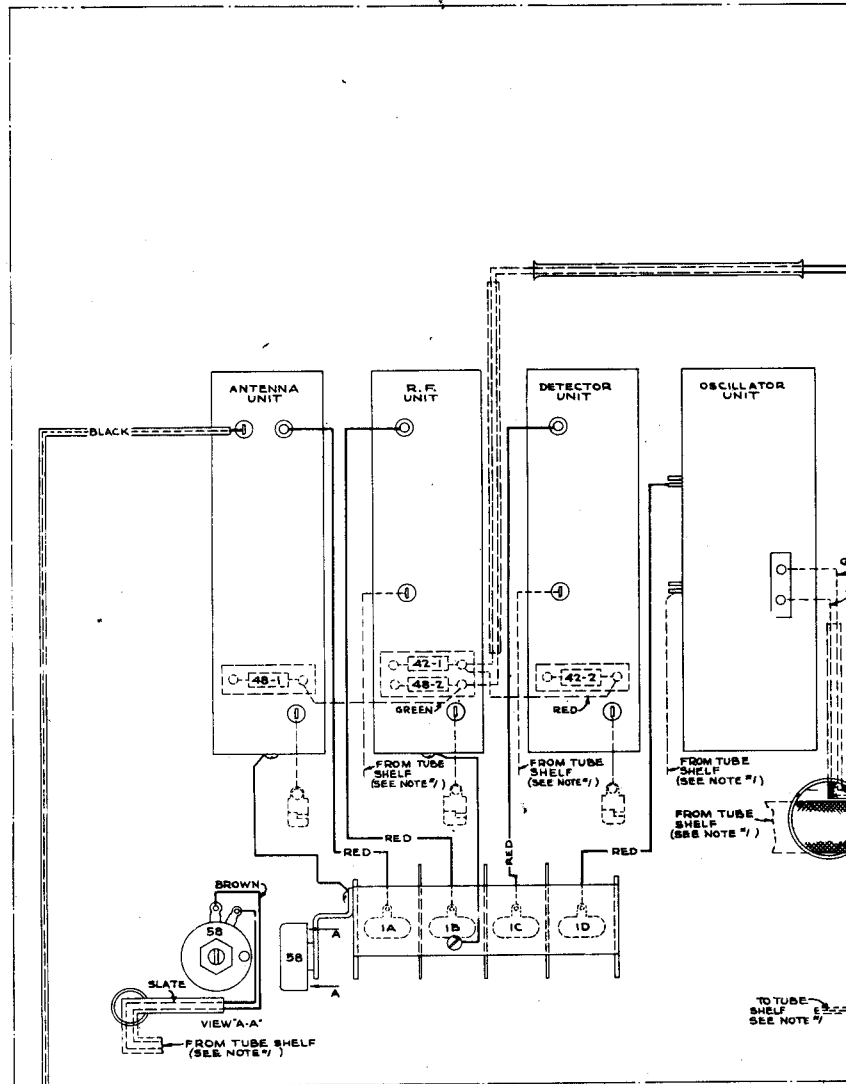

Figure 37 — Radio Receiver BC-348-(*), Pictorial Wiring Diagram



NOTE #1 - FROM RE...

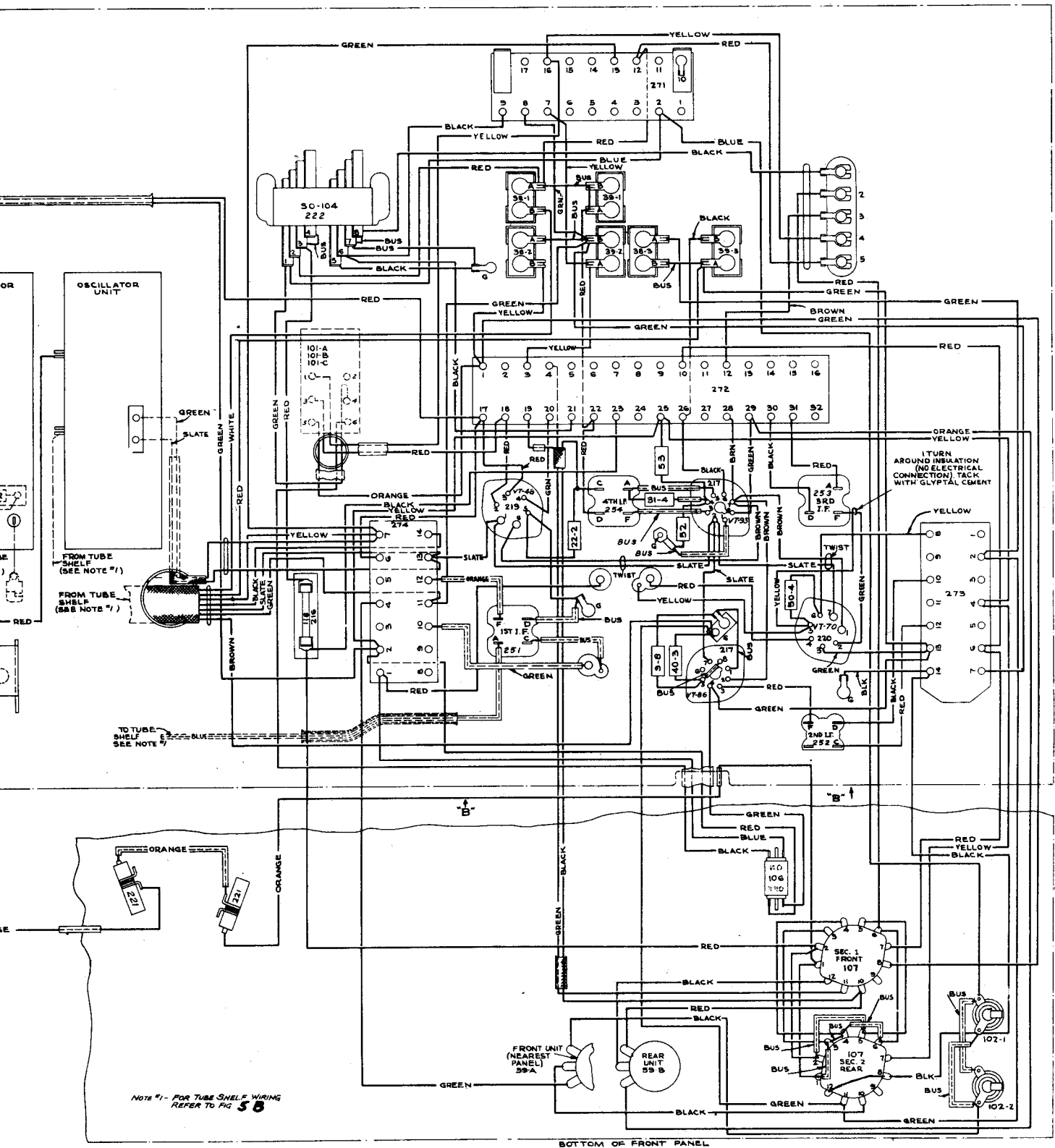

Figure 38 — Radio Receiver BC-224(*), Pictorial Wiring Diagram

RESTRICTED
AN 08-10-209

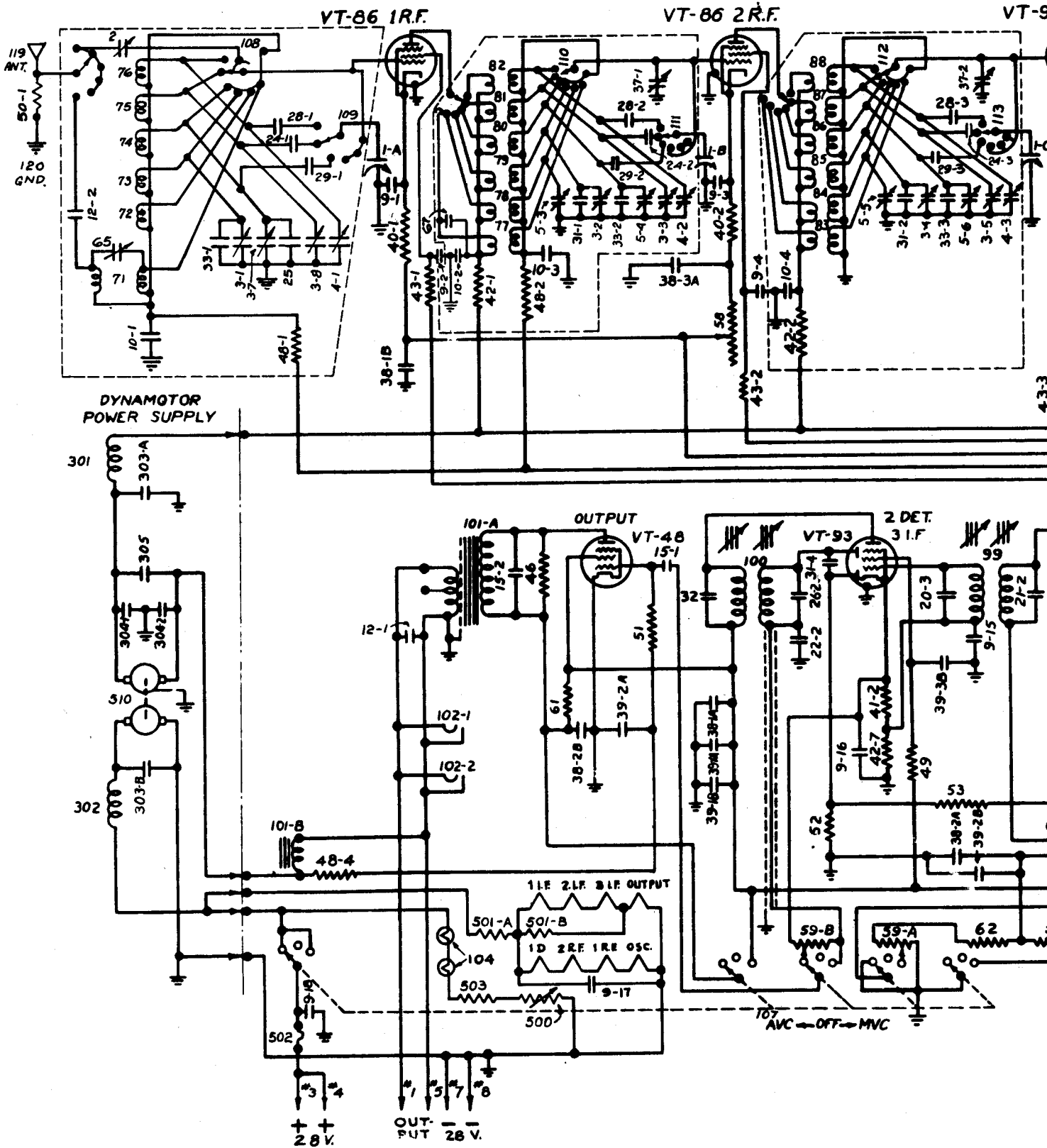

Figure 39 -

RESTRICTED

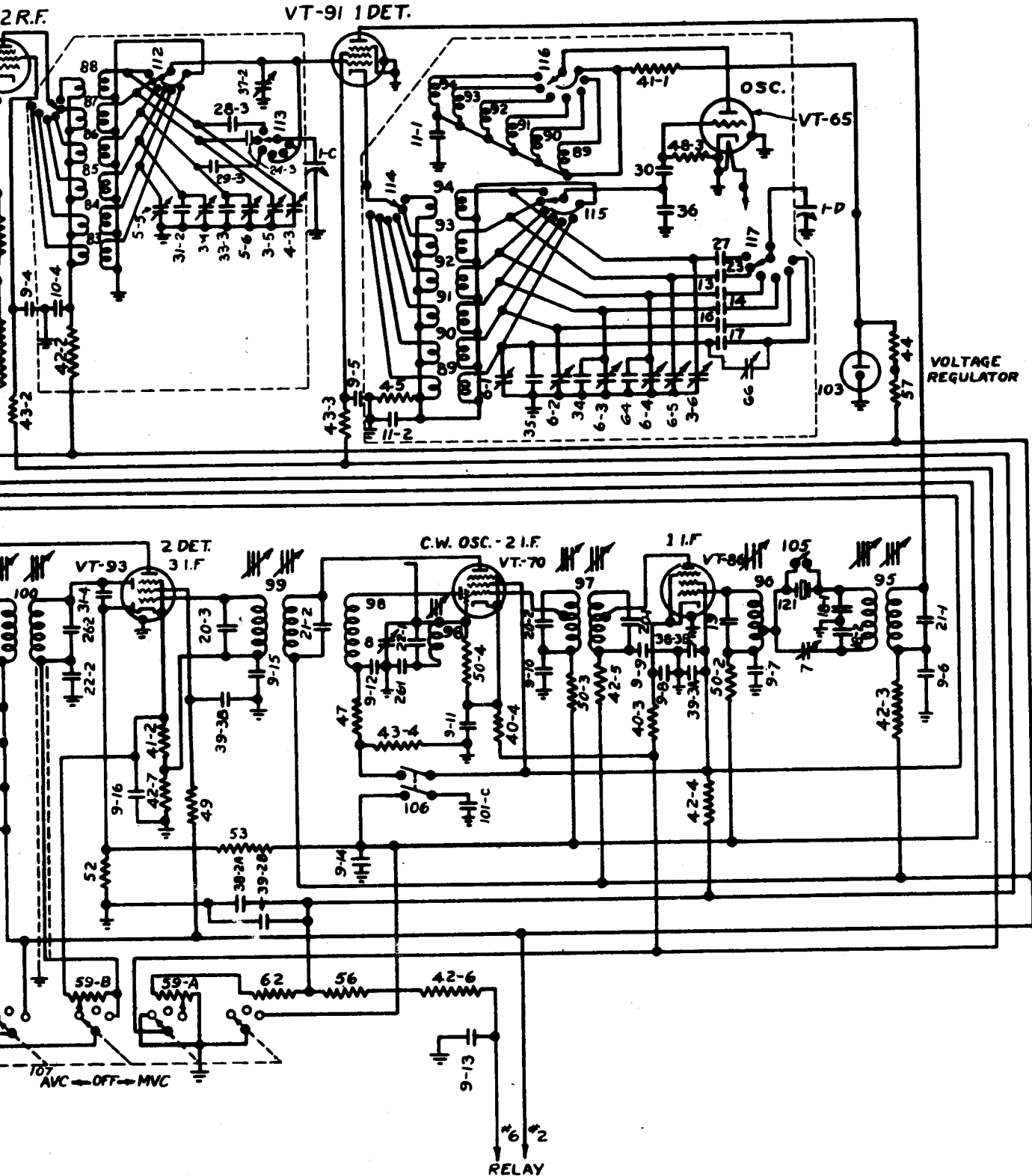

Figure 39 — Radio Receiver BC-348-O or BC-348-S, Schematic Circuit Diagram

RESTRICTED
AN 08-10-209

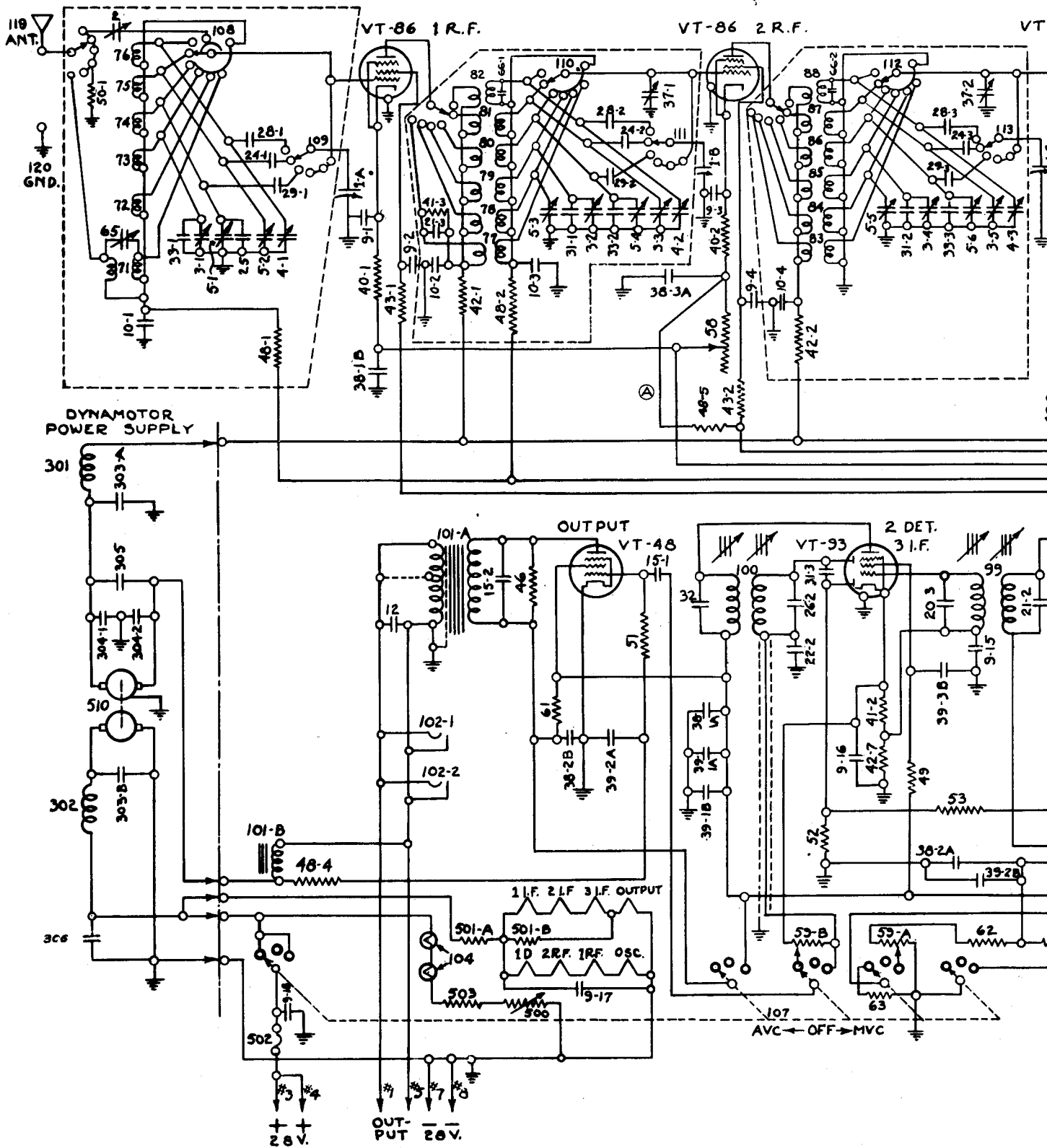

Figure 40 — R

RESTRICTED

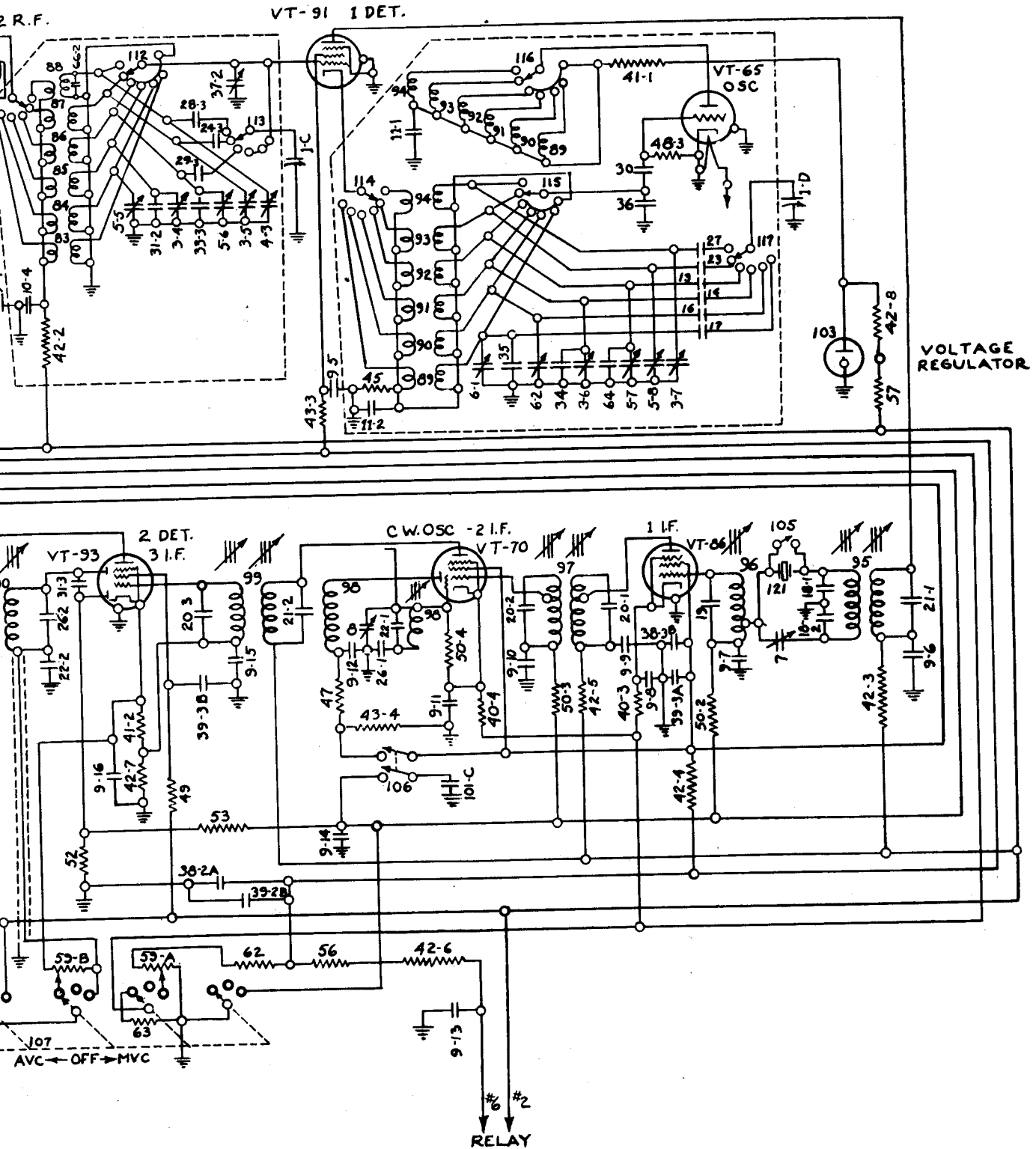
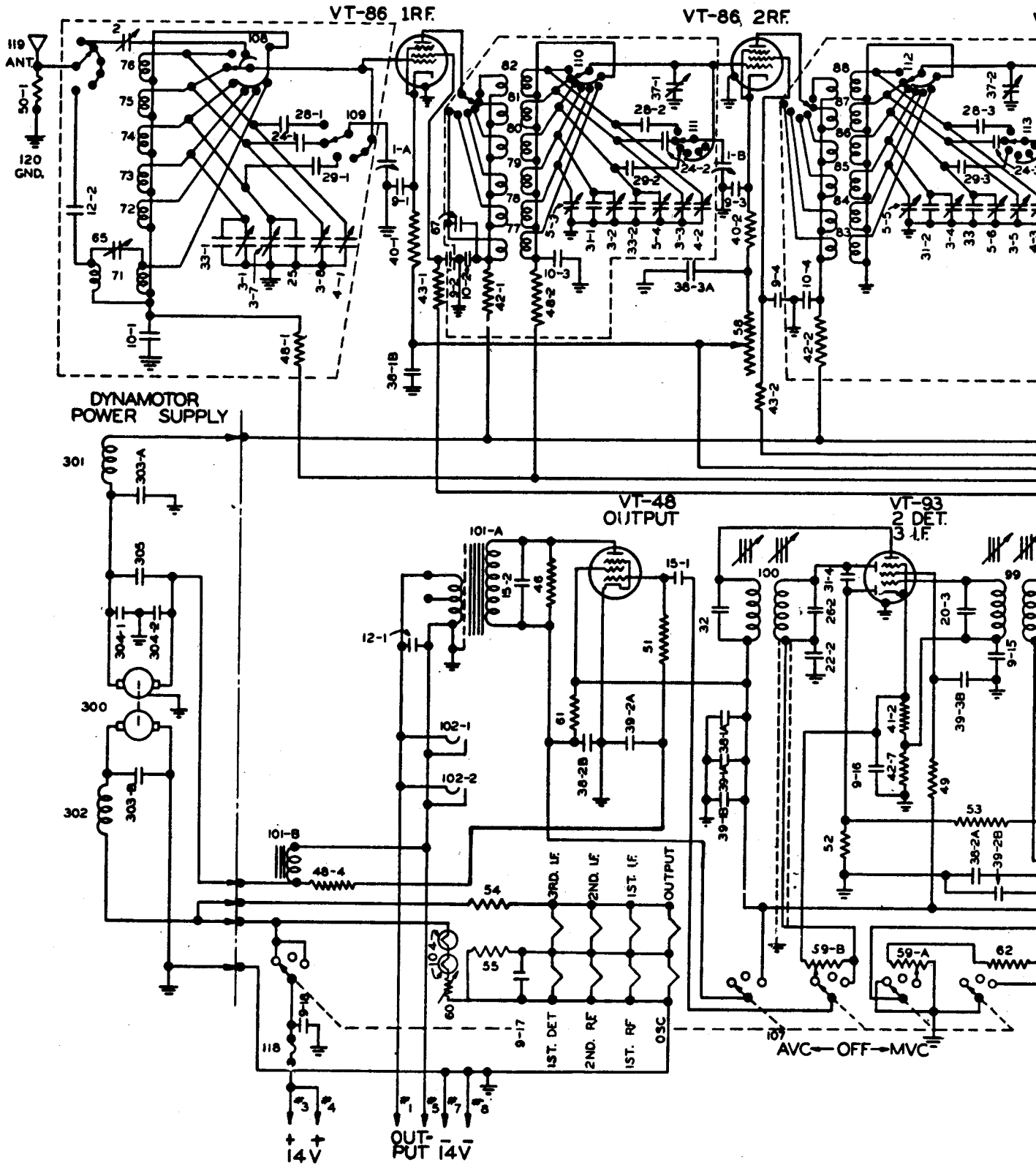

Figure 40 — Radio Receiver BC-348-E, BC-348-M or BC-348-P, Schematic Circuit Diagram

RESTRICTED
AN 08-10-209



RESTRICTED

Fig

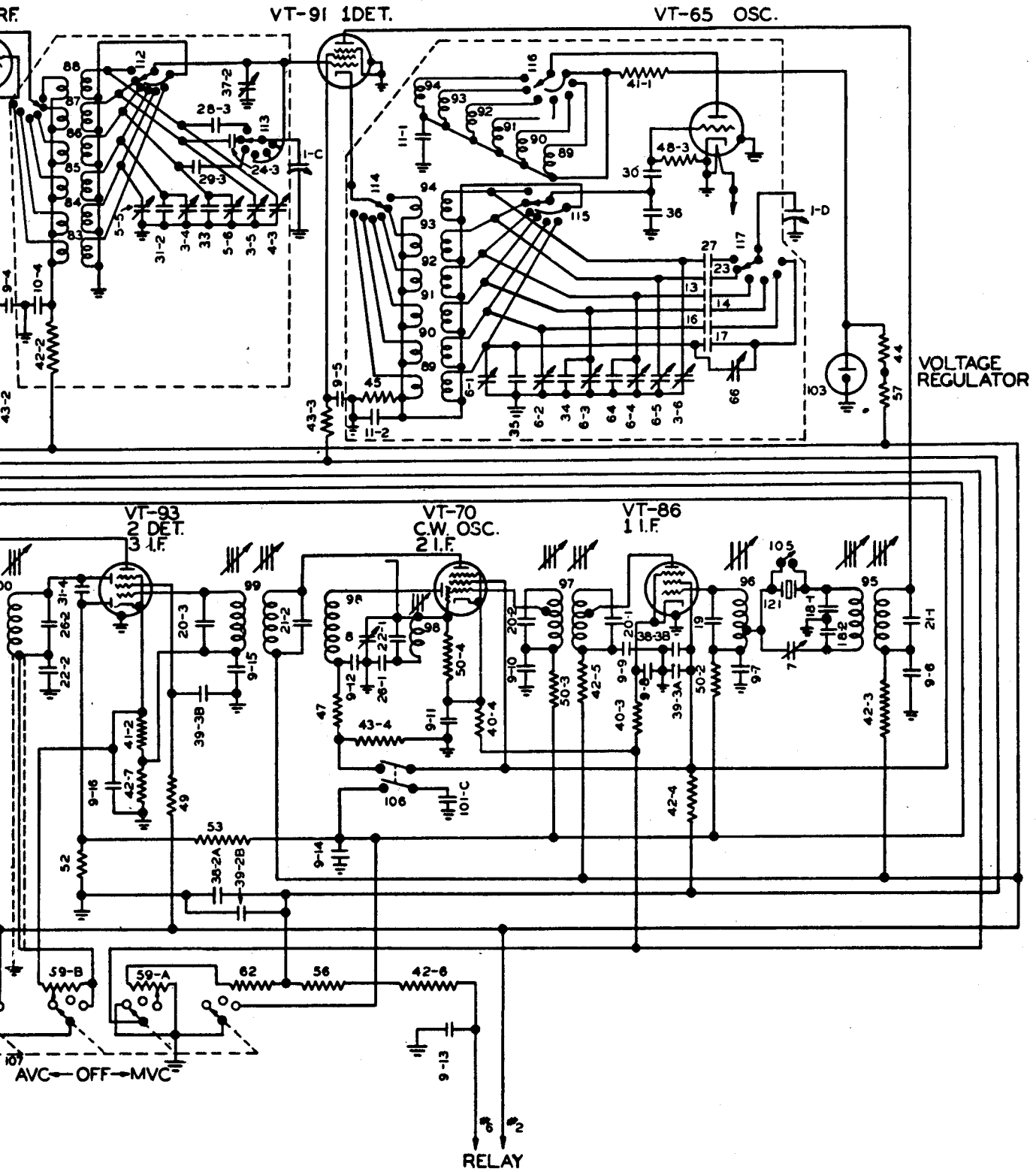

Figure 41 — Radio Receiver BC-224-(*), Schematic Circuit Diagram